

SIGNATURE

BY SCHAUB & CO.



ASSA ABLOY, the global leader in door opening solutions



Schaub
ASSA ABLOY

FINISHES

BLACK TONES

BB	Black Bronze
BC	Black Chrome
BN	Black Nickel
FB	Flat Black
MB	Matte Black
MB/15	Matte Black/Satin Nickel
MB/26	Matte Black/Polished Chrome

BRASS TONES

03	Polished Brass
AB	Antique Brass
ALB	Antique Light Brass
ALP	Antique Light Polish
RB	Redington Brass
SB	Satin Brass
SSB	Signature Satin Brass

BRONZE TONES

10B	Oil Rubbed Bronze
ABZ	Ancient Bronze
AUB	Aurora Bronze
AZ	Antique Bronze
BB	Black Bronze
BBZ	Brushed Bronze
BRBZ	Burnished Bronze
BZ	Bronze
DBZ	Distressed Bronze
DFBZ	Dark Firenza Bronze
EBZ	Empire Bronze
FAB	French Antique Bronze
LFBZ	Light Firenza Bronze
LTBZ	Light Bronze
MBZ	Milano Bronze
MIBZ	Michelangelo Bronze
NB	Natural Bronze
PWB	Polished White Bronze
VI	Verde Imperiale

CHROME TONES

26	Polished Chrome
26-CL	Polished Chrome Clear
26-SM	Polished Chrome Smoke
BC	Black Chrome
M26	Matte Chrome
MB/26	Matte Black/Polished Chrome

NICKEL TONES

15	Satin Nickel
15-CL	Satin Nickel Clear
15-SM	Satin Nickel Smoke
15S	Satin Nickel
AN	Antique Nickel
DN	Distressed Nickel
IN	Italian Nickel
LAN	Light Antique Nickel
MB/15	Matte Black/Satin Nickel
PN	Polished Nickel
VN	Vibra Nickel

PEWTER TONES

DP	Dark Pewter
DP/C	Distressed Pewter/Copper

SILVER TONES

AS	Antique Silver
CRS	Corinthian Silver
FS	Firenza Silver
MSV	Milano Silver
N	Natural Britannium
PWB	Polished White Bronze

SPECIALTY FINISHES

ES/15	Espresso Brown/Satin Nickel
ES/26	Espresso Brown/Polished Chrome
SS	Stainless Steel



On the Cover & This Page
Vinci cabinet hardware in Polished White Bronze
Photography by Love It or List It Vancouver



RUSTIC

- Vinci 7
- Mountain 8-9
- Martello 10
- Viento 11
- Perla & Chemin De Fer 12
- Artifex 13
- Ovale 14
- Siena 15

CONTEMPORARY

- Lumiere 17
- Positano 18-19
- Ice 20
- City Lights 21
- Tallmadge 23
- Mosaic 24
- Skyevale 25
- Finestrino 26
- Italian Contemporary 27
- Tenor 28
- Armadio 29
- Profile 30
- Regatta 31
- Aria 32
- Classico & Wave 33
- Sorrento 34
- Stainless Steel 35

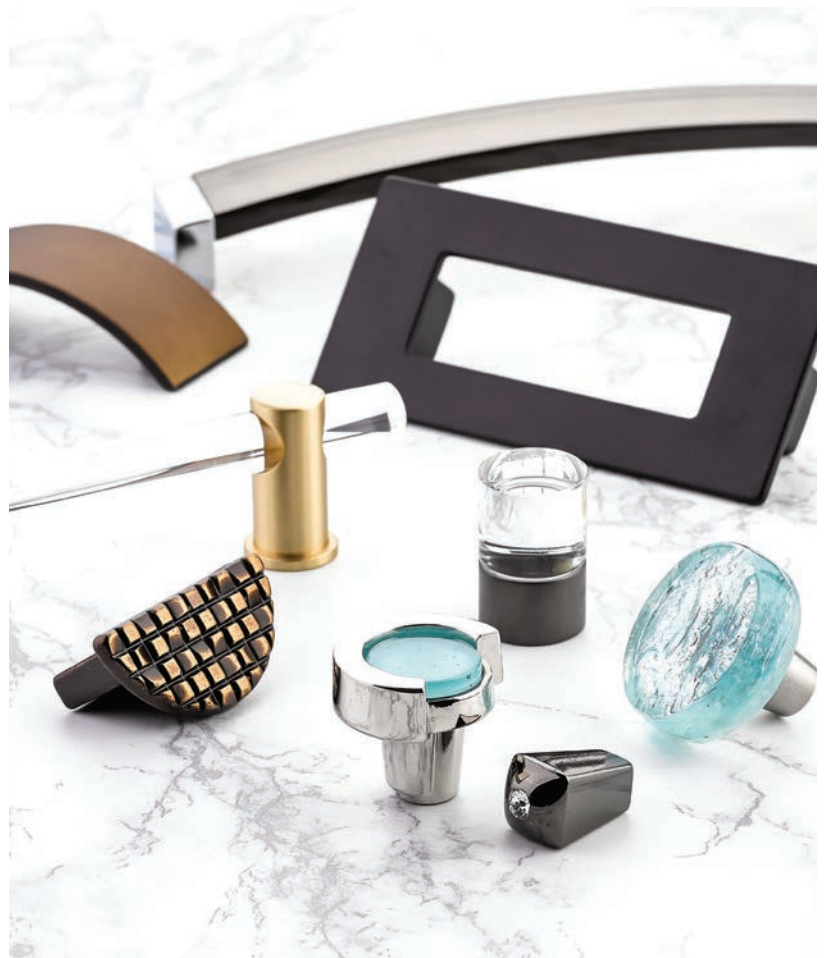



TRANSITIONAL

- Northport 37
- Steamworks 38
- Menlo Park 39
- Empire 40
- Stonehenge 41

TRADITIONAL

- Atherton 43
- Traditional 44-45
- Country 46
- Colonial 47
- Stargaze 48
- Kingsway 49
- Cabriole 50
- French Farm 51
- Meridian 52
- Montcalm 53
- Versailles 54
- Arcadia 55
- Casual Elegance 56
- Corinthian 57
- Firenze 58
- Hinges 59

- Index 60-67



RUSTIC

Rustic style honors the look, materials and techniques of craftsmanship from bygone eras and applies them to a range of design aesthetics. The use of authentic Bronze and Britannium provides each piece with organic surface qualities, imprinted from the ancient art of sand casting. Weathered silhouettes, combined with living finishes, gives Rustic designs a character all their own.



VINCI

MADE IN
ITALY



CAST BRONZE
Unlacquered Living Finish

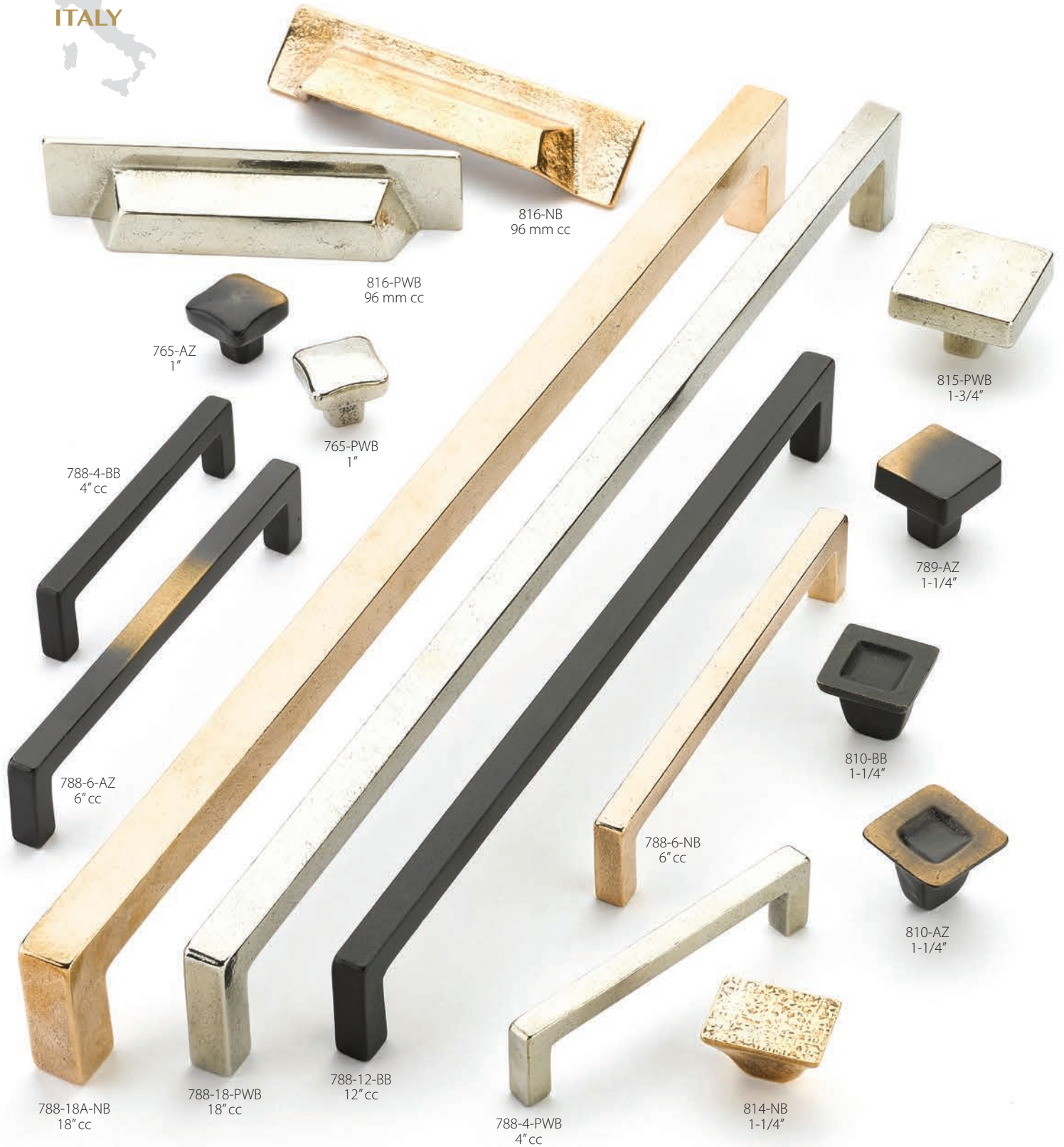

AZ-Antique Bronze • BB-Black Bronze • NB-Natural Bronze • PWB-Polished White Bronze

MOUNTAIN

CAST BRONZE
Unlacquered Living Finish

MADE IN
ITALY



772-VI
1-3/8"

771-IN
1-1/4"

773-NB
1-5/8"

777-VI
4" cc

778-NB
6" cc

779-AZ
12" cc

780-NB
18" cc

782-AS
1-7/8"

778-NB
1-3/8"

781-NB
1-3/8"

781-AZ
1-3/8"

778-AZ
6" cc

779-AS
12" cc

778-IN
6" cc

775-NB
3-1/2" cc

775-VI
3-1/2" cc

782-NB
1-7/8"

775-IN
3-1/2" cc

AS-Antique Silver • AZ-Antique Bronze • IN-Italian Nickel
NB-Natural Bronze • VI-Verde Imperiale

MOUNTAIN

MADE IN
ITALY



CAST BRONZE
Unlacquered Living Finish



AS-Antique Silver • AZ-Antique Bronze • IN-Italian Nickel
NB-Natural Bronze • VI-Verde Imperiale

MARTELLO

BRITANNIUM

Unlacquered Living Finish

MADE IN



N-Natural Britannium

Items in this design group are not intended for use as appliance pulls.

VIENTO

MADE IN



ITALY

BRITANNIUM
Unlacquered Living Finish



N-Natural Britannium

Items in this design group are not intended for use as appliance pulls.

PERLA & CHEMIN DE FER

BRITANNIUM

Unlacquered Living Finish

MADE IN



N-Natural Britannium

ARTIFEX

MADE IN
ITALY



BRITANNIUM
Unlacquered Living Finish



DP-Dark Pewter • N-Natural Britannium

OVALE

CAST BRONZE
Unlacquered Living Finish

MADE IN
ITALY



787-96-AZ
96 mm cc



808-PWB
1-1/4"



805-AZ
1-1/4"

787-128-AZ
128 mm cc



776-AZ
1-3/4"



787-5-AZ
5" cc



776-PWB
1-3/4"



782-PWB
1-7/8"

787-96-PWB
96 mm cc



781-AZ
1-3/8"



787-128-PWB
128 mm cc

787-18-AZ
18" cc

787-10-PWB
10" cc

787-5-PWB
5" cc



809-PWB
1-1/4"



809-AZ
1-1/4"

AZ-Antique Bronze • PWB-Polished White Bronze

SIENA



ABZ-Ancient Bronze • VN-Vibra Nickel

CONTEMPORARY

Contemporary designs pay homage to modern art and architecture in their sleek and unadorned styling. These sophisticated pieces offer strong and simple lines in often bold colors and materials. Sleek and understated, functional and minimal, Contemporary cabinet hardware complements many design themes and can elevate any project.



LUMIERE

ADJUSTABLE
ACRYLIC PULLS



10B-Oil Rubbed Bronze • 15-Satin Nickel • 26-Polished Chrome
PN-Polished Nickel • SB-Satin Brass

POSITANO

MADE IN
ITALY



321-15-SM
160 mm cc

318-26-SM
320 mm cc

317-15-SM
160 mm cc

316-15-SM
128 mm cc

319-26-SM
16 mm cc

315-26-SM
64 mm cc

322-26-CL
224 mm cc

315-26-CL
64 mm cc

318-26-CL
320 mm cc

320-15-CL
128 mm cc

317-15-CL
160 mm cc

316-15-CL
128 mm cc

15-CL-Satin Nickel Clear • 15-SM-Satin Nickel Smoke
26-CL-Polished Chrome Clear • 26-SM-Polished Chrome Smoke

Items in this design group are not intended for use as appliance pulls.

POSITANO

MADE IN
ITALY



15-CL-Satin Nickel Clear • 15-SM-Satin Nickel Smoke
26-CL-Polished Chrome Clear • 26-SM-Polished Chrome Smoke



We recommend Positano edge pulls be installed on flat panel cabinets with a maximum thickness of 3/4" in order to achieve proper clearance. Edge pulls attach from inside drawer or cabinet face.

ICE

MADE IN



COO-Confetti Orange • COT-Confetti Turquoise • CWG-Confetti White Grey
 GBP-Green Blue Pebbles • IVS-Ivory Silk • PAQ-Pearl Aqua • PBL-Pearl Blue • PCL-Pearl Clear
 SBP-Sable Pebbles • SCS-Scarlet Silk • SPS-Sapphire Silk • WLP-White Lace Pebbles

CITY LIGHTS



10B-Oil Rubbed Bronze • 15-Satin Nickel • 26-Polished Chrome
PN-Polished Nickel • SB-Satin Brass



TALLMADGE



Finish and Glass combinations:

Black Nickel (BN) Finish: Light Bronze (LB), Lemon Ice (LM) or Rouge (RG)
 Polished Nickel (PN) Finish: Silver Grey (GY), Turquoise (TQ) or White (WH)
 Satin Nickel (SN) Finish: Black (BL), Steel Blue (SB) or White (WH)

MOSAIC

MADE IN



15-Satin Nickel • 26-Polished Chrome • FAB-French Antique Bronze

Items in this design group are not intended for use as appliance pulls.

SKYEVALE

MADE IN
ITALY



300-MSV
1/2"



299-15
1/2"



299-BC
1/2"



305-BC
128/160 mm cc



302-MSV
128/160 mm cc



306-15
288/320 mm cc



305-MSV
128/160 mm cc



303-BC
288/320 mm cc



304-BC
32 mm cc

302-15
128/160 mm cc



302-26
128/160 mm cc



301-26
32 mm cc

305-MBZ
128/160 mm cc



301-15
32 mm cc



301-MSV
32 mm cc

304-MBZ
32 mm cc



15-Satin Nickel • 26-Polished Chrome • BC-Black Chrome
MBZ-Milano Bronze • MSV-Milano Silver

Items in this design group are not intended for use as appliance pulls.

FINESTRINO

MADE IN



445-26
128 mm cc



440-26
32 mm cc



444-M26
96 mm cc



441-15
64 mm cc

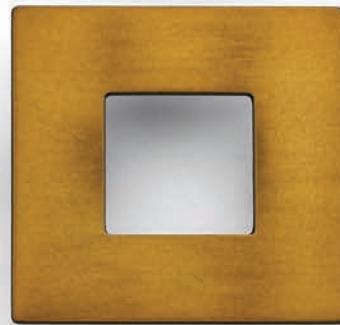

443-BRBZ
64 mm cc



442-15
160 mm cc



446-MB
192 mm cc



450-MB
32 mm cc



451-M26
160 mm cc

15-Satin Nickel • 26-Polished Chrome • BRBZ-Burnished Bronze
M26-Matte Chrome • MB-Matte Black

ITALIAN CONTEMPORARY

MADE IN
ITALY



SOLID
BRASS



15-Satin Nickel • 26-Polished Chrome • LTBZ-Light Bronze

TENOR

MADE IN



ITALY



246-128-15
128 mm cc

246-384-ES/15
384 mm cc

245-128-ES/15
128 mm cc

246-224-ES/26
224 mm cc

246-224-15
224 mm cc

245-224-ES/26
224 mm cc

246-160-ES/15
160 mm cc

245-224-15
224 mm cc

245-160-ES/15
160 mm cc

246-288-ES/26
288 mm cc

246-128-ES/26
128 mm cc

245-384-ES/26
384 mm cc

245-128-15
128 mm cc

15-Satin Nickel • ES/15-Espresso Brown/Satin Nickel • ES/26-Espresso Brown/Polished Chrome

Items in this design group are not intended for use as appliance pulls.

ARMADIO

MADE IN

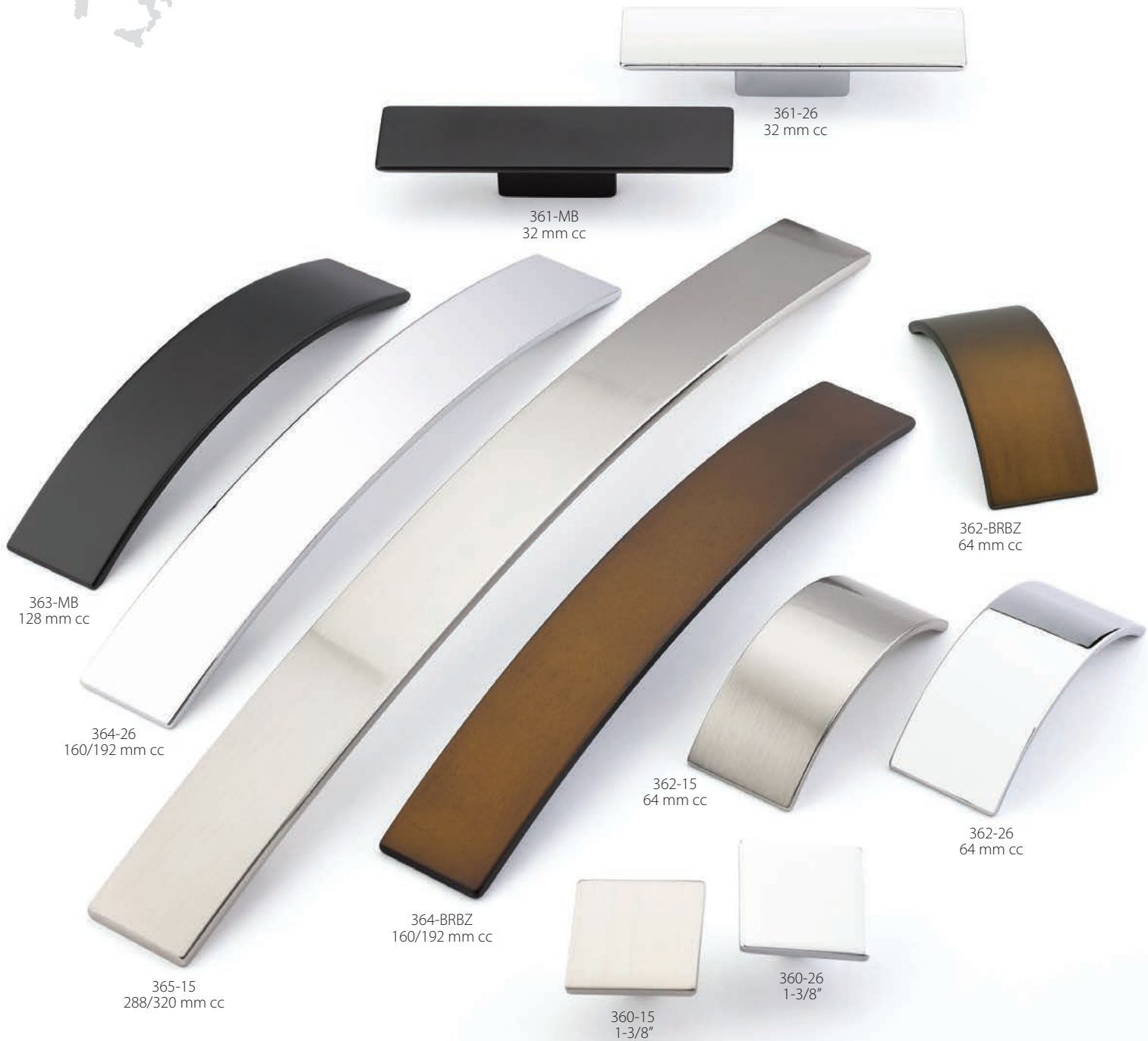

15-Satin Nickel • 26-Polished Chrome • BRBZ-Burnished Bronze • MB-Matte Black

Items in this design group are not intended for use as appliance pulls.

PROFILE

MADE IN



15-Satin Nickel • 26-Polished Chrome • M26-Matte Chrome • MB-Matte Black

Items in this design group are not intended for use as appliance pulls.

REGATTA

MADE IN

ITALY



15-Satin Nickel • 26-Polished Chrome • MB/15-Matte Black/Satin Nickel
MB/26-Matte Black/Polished Chrome

Items in this design group are not intended for use as appliance pulls.

ARIA

MADE IN

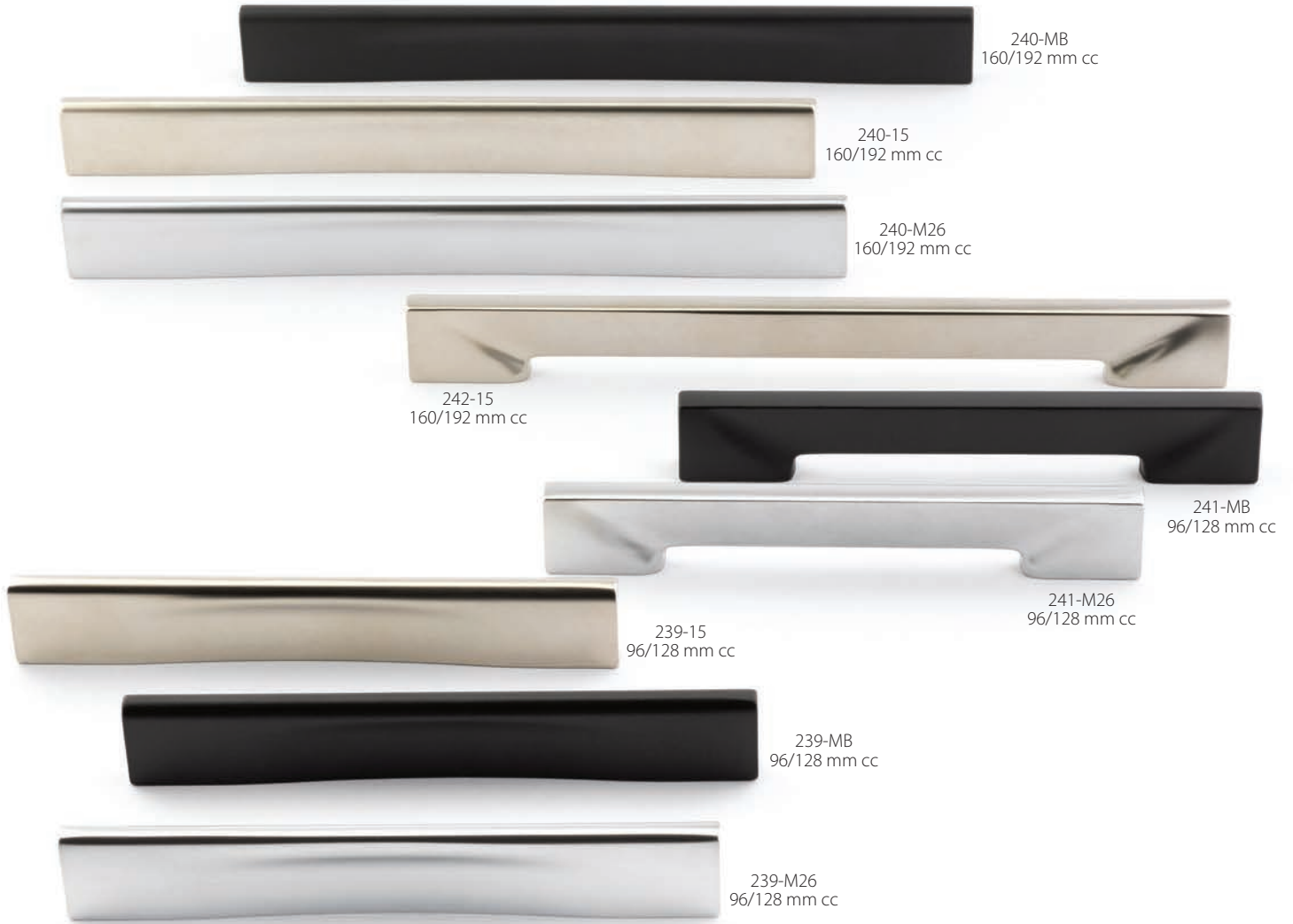

15-Satin Nickel • M26-Matte Chrome • MB-Matte Black

CLASSICO & WAVE

MADE IN
ITALY



15S-Satin Nickel • 26-Polished Chrome • M26-Matte Chrome • MB-Matte Black

Items in this design group are not intended for use as appliance pulls.

SORRENTO

MADE IN
ITALY



313-26
160/192 mm cc

313-MSV
160/192 mm cc

314-15
288/320 mm cc

311-BC
448/480 mm cc

310-MB
288/320 mm cc

309-MBZ
160/192 mm cc

307-26
32 mm cc

307-MB
32 mm cc

312-BC
96/128 mm cc

312-MB
96/128 mm cc

308-MSV
96/128 mm cc

308-15
96/128 mm cc

15-Satin Nickel • 26-Polished Chrome • BC-Black Chrome
MB-Matte Black • MBZ-Milano Bronze • MSV-Milano Silver

Items in this design group are not intended for use as appliance pulls.

STAINLESS STEEL



Solid Stainless Steel

Items in this design group are not intended for use as appliance pulls.

PART NUMBER, SIZE & DESCRIPTION

SS 010	Whistle Knob, 20 mm Diameter	SS 288	Bar Pull, 288 mm cc (348 mm overall, 13-3/4")	SS BOW 096	Bow Pull, 96 mm cc (115 mm overall, 4-1/2")
SS 012	Round Knob, 30 mm Diameter	SS 384	Bar Pull, 384 mm cc (444 mm overall, 17-1/2")	SS BOW 128	Bow Pull, 128 mm cc (156 mm overall, 6-1/8")
SS 014	"T" Knob, 35 mm x 35 mm	SS 448	Bar Pull, 448 mm cc (508 mm overall, 20")	SS BOW 224	Bow Pull, 224 mm cc (263 mm overall, 10-1/3")
SS 096	Bar Pull, 96 mm cc (156 mm overall, 6-1/8")	SS 544	Bar Pull, 544 mm cc (604 mm overall, 23-3/4")	SS BOW 288	Bow Pull, 288 mm cc (340 mm overall, 13-2/5")
SS 128	Bar Pull, 128 mm cc (188 mm overall, 7-3/8")	SS 640	Bar Pull, 640 mm cc (700 mm overall, 27-1/2")		
SS 160	Bar Pull, 160 mm cc (220 mm overall, 8-5/8")	SS 736	Bar Pull, 736 mm cc (796 mm overall, 31-3/8")		
SS 224	Bar Pull, 224 mm cc (284 mm overall, 11-1/8")	SS 832	Bar Pull, 832 mm cc (892 mm overall, 35-1/8")		

NORTHPORT



15-Satin Nickel • ABZ-Ancient Bronze • BBZ-Brushed Bronze • PN-Polished Nickel

STEAMWORKS



15-Satin Nickel • BBZ-Brushed Bronze • DP/C-Distressed Pewter/Copper • EBZ-Empire Bronze

MENLO PARK



15-Satin Nickel • 26-Polished Chrome • ABZ-Ancient Bronze
 PN-Polished Nickel • SSB-Signature Satin Brass

EMPIRE



15-Satin Nickel • ABZ-Ancient Bronze • AN-Antique Nickel • BBZ-Brushed Bronze
 EBZ-Empire Bronze • PN-Polished Nickel

STONEHENGE



ABZ-Ancient Bronze • AN-Antique Nickel • BBZ-Brushed Bronze • PN-Polished Nickel

TRADITIONAL

Traditional designs include elegant accents and familiar, timeless shapes. Elements of classic European architecture and style shine through in measured details, from antique-inspired engravings and rich metallic hues, to intricately adorned silhouettes and baroque textures. These venerable designs stand the test of time.



ATHERTON



10B-Oil Rubbed Bronze • 26-Polished Chrome • PN-Polished Nickel • SB-Satin Brass

TRADITIONAL

SOLID
BRASS



03-Polished Brass • 10B-Oil Rubbed Bronze • AB-Antique Brass
ALB-Antique Light Brass • DBZ-Distressed Bronze • MIBZ-Michelangelo Bronze

TRADITIONAL

SOLID
BRASS



15-Satin Nickel • 26-Polished Chrome • AN-Antique Nickel
DN-Distressed Nickel • FB-Flat Black • PN-Polished Nickel

COUNTRY

SOLID
BRASS



10B-Oil Rubbed Bronze • 15-Satin Nickel • 26-Polished Chrome
AN-Antique Nickel • AUB-Aurora Bronze • FB-Flat Black • PN-Polished Nickel

COLONIAL

SOLID
BRASS



10B-Oil Rubbed Bronze • 15-Satin Nickel • 26-Polished Chrome
AN-Antique Nickel • AUB-Aurora Bronze • FB-Flat Black • PN-Polished Nickel

STARGAZE



03-Polished Brass • 15-Satin Nickel • BZ-Bronze • PN-Polished Nickel

KINGSWAY

MADE IN



20-PN-SG
1-1/4"



20-ABZ-AL
1-1/4"



21-AN-CH
1-1/4"



21-PN-CB
1-1/4"



20-ABZ-SC
1-1/4"



20-PN-CW
1-1/4"



22-PN-SG
4" cc



22-ABZ-SC
4" cc



21-ABZ-CL
1-1/4"



20-PN-CB
1-1/4"



22-AN-GS
4" cc



21-AN-GS
1-1/4"



22-ABZ-CL
4" cc



20-AN-GB
1-1/4"



21-AN-GB
1-1/4"

Finish and Glass combinations:

Ancient Bronze (ABZ) Finish: Almond (AL), Chaparral (CL) or Scarlet (SC)

Antique Nickel (AN) Finish: Champagne (CH), Glacier Blue (GB) or Greystone (GS)

Polished Nickel (PN) Finish: Classic Black (CB), Classic White (CW) or Slate Grey (SG)

CABRIOLE



AN-Antique Nickel • BBZ-Brushed Bronze • EBZ-Empire Bronze • PN-Polished Nickel

FRENCH FARM



ABZ-Ancient Bronze • AN-Antique Nickel • EBZ-Empire Bronze

MERIDIAN

SOLID
BRASS



10B-Oil Rubbed Bronze • 15-Satin Nickel • ALP-Antique Light Polish
AN-Antique Nickel • AUB-Aurora Bronze • PN-Polished Nickel

MONTCALM

SOLID
BRASS



10B-Oil Rubbed Bronze • 15-Satin Nickel • ALP-Antique Light Polish
AN-Antique Nickel • MIBZ-Michelangelo Bronze • PN-Polished Nickel

VERSAILLES

SOLID
BRASS



752-10B
1-1/2"



753-10B
3" cc



754-10B
3-1/2" cc



751-10B
1-1/4"

761-10B
BACKPLATE
4-1/4" x 1"



762-10B
96 mm cc

763-10B
BACKPLATE
96 mm cc



764-ALP
10" cc



754-ALP
3-1/2" cc



753-ALP
3" cc



752-15
1-1/2"

756-15
BACKPLATE
1-1/2"



751-ALP
1-1/4"

761-ALP
BACKPLATE
4-1/4" x 1"



753-15
3" cc



754-15
3-1/2" cc

10B-Oil Rubbed Bronze • 15-Satin Nickel • ALP-Antique Light Polish

ARCADIA

SOLID
BRASS



831-ALB
1-3/4"

832-ALB
BACKPLATE
4-1/4" x 7/8"

830-AN
1-3/8"

834-ALB
3" cc

834-AN
3" cc

833-ALB
96 mm cc

836-AN
6" cc

833-ABZ
96 mm cc

836-ABZ
6" cc

835-AN
15" cc

830-ABZ
1-3/8"

832-ABZ
BACKPLATE
4-1/4" x 7/8"

ABZ-Ancient Bronze • ALB-Antique Light Brass • AN-Antique Nickel

CORINTHIAN

SOLID
BRASS



ABZ-Ancient Bronze • CRS-Corinthian Silver • MIBZ-Michelangelo Bronze • RB-Redington Brass

FIRENZA

MADE IN



ITALY



282-DFBZ
96 mm cc



282-LFBZ
96 mm cc



282-FS
96 mm cc



280-LFBZ
96/128 mm cc



280-FS
96/128 mm cc



283-DFBZ
1-1/8"



283-FS
1-1/8"



283-LFBZ
1-1/8"



281-LFBZ
96 mm cc



280-DFBZ
96/128 mm cc



281-FS
96 mm cc



284-LFBZ
128 mm cc



284-FS
128 mm cc



284-DFBZ
128 mm cc



281-DFBZ
96 mm cc

DFBZ-Dark Firenza Bronze • FS-Firenza Silver • LFBZ-Light Firenza Bronze

HINGES

**SOLID
BRASS**

MORTISE HINGES

AVAILABLE IN BALL TIP ONLY

* Hinges available in all finishes shown, sold as eaches.



1111B-DN

1111B-DBZ

1111B-ALB

1111B-26

1111B-FB

1111B-AB

NON-MORTISE HINGES

AVAILABLE IN BALL TIP & MINARET

* Hinges available in all finishes shown, sold as eaches.



1100B-10B

1100B-PN

1100B-MIBZ

1100M-15

1100M-AN

1100M-03

SPECIFICATIONS

HINGE THICKNESS = 1/16"

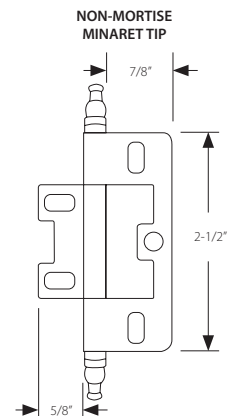
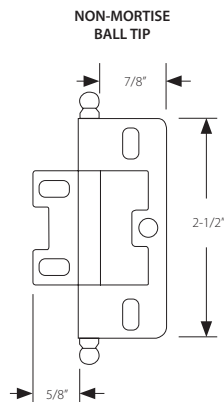
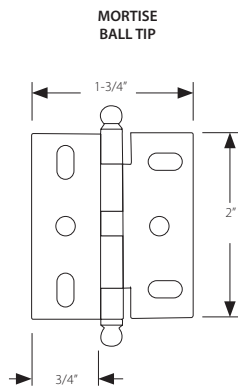

INDEX

PART #	PAGE #	PULL CENTER TO CENTER	KNOB DIAMETER	PROJECTION	BASE DIAMETER	OVERALL	SCREW SIZE
20-__	49		1-1/4"	1"	1"		#8-32
21-__	49		1-1/4"	1"	1"		#8-32
22-__	49	4"		1-1/8"	3/4"	5"	#8-32
25-__	23		1-1/4"	1-1/4"	1/2"		#8-32
26-__	23		1-1/4"	1-1/4"	1/2"		#8-32
27-__	23	4"		1-1/4"	1/2" x 3/8"	5-7/8"	#8-32
30-__	20	3"		1"	1/2"	4-1/2"	#8-32
31-__	20		1-1/2"	1"	1/2"		#8-32
34-__	20		1-1/2" x 1-1/2"	1"	1/2"		#8-32
63-__	50		1-1/8"	1"	7/8"		#8-32
64-__	50	96 mm		1-3/8"	3/8"	4"	#8-32
64-6-__	50	6"		1-1/2"	1/2"	6-1/2"	#8-32
64-8-__	50	8"		1-5/8"	1/2"	8-1/2"	#8-32
64-13-__	50	13"		2-1/2"	5/8" x 7/8"	14"	1/4-20
70-__	48		1-1/8"	1-5/8"	3/4"		#8-32
71-__	48		1-1/4"	1-1/8"	3/4"		#8-32
72-__	48		1-1/16"	1-1/16"	3/4"		#8-32
74-__	21		7/8"	1-1/4"	7/8"		#8-32
76-__	21		1-1/8"	1-3/8"	1-1/8"		#8-32
77-__	21		1-3/8"	3/4"	1-1/4"		#8-32
78-__	38		1-1/4"	1"	3/4"		#8-32
79-__	38	96 mm		1-1/4"	1/2"	4-1/2"	#8-32
79-6-__	38	6"		1-1/4"	1/2"	7"	#8-32
79-8-__	38	8"		1-3/8"	5/8"	9-1/4"	#8-32
79-12-__	38	12"		2"	7/8"	13-7/8"	1/4-20
79-15-__	38	15"		2-1/4"	1"	17"	1/4-20
1100B-__	59			1/16"	2-1/2" x 7/8"	3"-L	#5
1100M-__	59			1/16"	2-1/2" x 7/8"	3-5/8"-L	#5
1111B-__	59			1/16"	2" x 3/4"	2-5/8"-L	#5
131-__	13		1-1/2"	1-3/8"	5/8"		M4
132-__	13		1-1/8"	1-1/4"	5/8"		M4
133-__	12		1-3/4" x 1"	1-1/4"	5/8"		M4
134-__	12		1-3/8"	1-1/4"	5/8"		M4
135-__	12		1-3/8"	1-1/4"	5/8"		M4
136-__	12	128 mm		1-1/8"	1-3/8"	6-1/2"	M4
137-__	12	64 mm		1-1/8"		3-3/8" x 1-1/4"	M4
139-__	12	12"		1-1/2"	2"	15"	M4
140-__	12	12"		2-1/8"	2-1/2"	16-1/8"	M6
141-64-__	12	64 mm		1-1/8"	1/2"	3-3/4"	M4
141-96-__	12	96 mm		1-1/8"	1/2"	5"	M4
141-128-__	12	128 mm		1-1/8"	9/16"	6-5/8"	M4
141-224-__	12	224 mm		1-3/8"	9/16"	10"	M4

INDEX

PART #	PAGE #	PULL CENTER TO CENTER	KNOB DIAMETER	PROJECTION	BASE DIAMETER	OVERALL	SCREW SIZE
141-384-__	12	384 mm		1-3/8"	5/8"	16-3/4"	M4
143-300-__	12	300 mm		2-1/2"	1-1/16"	14-3/8"	M6
144-__	12			1-1/8"	1/2"	1-3/4"	M4
170-__	10		1-3/4"	1"	1/2"		M4
171-__	10		1-1/2" x 1-1/2"	1"	1/2"		M4
172-__	10		1-3/4" x 1-1/8"	1"	1/2"		M4
173-__	10	96 mm		3/4"	1/2"	4-1/2" x 1-5/8"	M4
174-__	10	128 mm		1"	3/8" x 1"	5-1/2"	M4
175-__	10	160 mm		1-1/8"	7/8" x 1/2"	6-7/8"	M4
176-__	10	128 mm		1-3/8"	1/2"	7"	M4
177-__	10	160 mm		1-3/8"	1/2"	8-1/2"	M4
178-__	10	224 mm		1-3/8"	1/2"	10-7/8"	M4
179-__	10	305 mm		1-3/8"	1/2"	14"	M4
180-__	11		1-3/4"	1"	1/2"		M4
181-__	11		1-1/2" x 1-1/2"	1"	1/2"		M4
182-__	11		1-3/4" x 1-1/8"	1"	1/2"		M4
183-__	11	96 mm		3/4"	1/2"	4-1/2" x 1-5/8"	M4
184-__	11	128 mm cc		1"	3/8" x 1"	5-1/2"	M4
185-__	11	160 mm cc		1-1/8"	7/8" x 1/2"	6-7/8"	M4
186-__	11	128 mm cc		1-3/8"	1/2"	7"	M4
187-__	11	160 mm cc		1-3/8"	1/2"	8-1/2"	M4
188-__	11	224 mm cc		1-3/8"	1/2"	10-7/8"	M4
189-__	11	305 mm cc		1-3/8"	1/2"	14"	M4
210-__	37		1-3/8"	1-1/8"	1"		#8-32
211-__	37		1-3/8"	1-1/8"	1"		#8-32
212-__	37	5"		1-3/16"	1 1/4"	6"	#8-32
213-__	37	8"		1-1/4"	1-1/4"	9"	#8-32
214-__	37	15"		1-7/8"	1-3/8"	16"	1/4-20
215-__	37		1-3/8"	1-1/8"	1"		#8-32
216-__	37	5"		1-3/16"	1"	6"	#8-32
217-__	37	8"		1-1/4"	1-1/4"	9"	#8-32
218-__	37	15"		1-3/4"	1-3/8"	16-1/2"	1/4-20
219-__	37		1-3/8"	1-1/8"	1"		#8-32
221-__	33	128 mm		7/8"	5/8" x 1/2"	5-3/8"	M4
222-__	33	160 mm		7/8"	5/8" x 1/2"	6-3/4"	M4
223-__	33	192 mm		7/8"	5/8" x 1/2"	8-1/8"	M4
224-__	33	320 mm		7/8"	5/8" x 1/2"	13-1/8"	M4
233-__	24	320 mm		1"	1/2" x 1/4"	14-1/2"	M4
234-__	24	32 mm	1-7/8"	7/8"	1-5/8" x 3/8"	1-7/8"	M4
2340-__	24	32 mm	2"	1"	1-1/2" x 1/4"		M4
235-__	24	32 mm		7/8"	1-5/8" x 3/8"	1" x 1-7/8"	M4
236-__	24	128 mm		1"	1/2" x 1/4"	6-1/2" x 1"	M4

INDEX

PART #	PAGE #	PULL CENTER TO CENTER	KNOB DIAMETER	PROJECTION	BASE DIAMETER	OVERALL	SCREW SIZE
2360-__	24	96 mm		7/8"	3/8"	5-1/4"	M4
237-__	24	32 mm		7/8"	1-5/8" x 3/8"	1" x 1-7/8"	M4
2370-__	24		1-1/8"	3/4"	1/2"		M4
239-__	32	96/128 mm		7/8"	1/4"	5-1/2"	M4
240-__	32	160/192 mm		7/8"	1/4"	8"	M4
241-__	32	96/128 mm		7/8"	3/8"	5-1/2"	M4
242-__	32	160/192 mm		7/8"	3/8"	8"	M4
244-064-__	33	64 mm		7/8"		3-5/8" x 3/4"	M4
244-160-__	33	160 mm		1"		7-3/4" x 1"	M4
244-192-__	33	192 mm		1"		9-1/4" x 1"	M4
244-320-__	33	320 mm		1"		14-1/4" x 1"	M4
245-128-__	28	128 mm		1-3/8"		5-1/2" x 1-1/4"	M4
245-160-__	28	160 mm		1-3/8"		6-3/4" x 1-1/4"	M4
245-224-__	28	224 mm		1-3/8"		9-1/4" x 1-1/4"	M4
245-288-__	28	288 mm		1-3/8"		11-3/4" x 1-1/4"	M4
245-384-__	28	384 mm		1-3/8"		15-1/2" x 1-1/4"	M4
246-128-__	28	128 mm		1-5/8"		5-1/2" x 3/8"	M4
246-160-__	28	160 mm		1-5/8"		6-3/4" x 3/8"	M4
246-224-__	28	224 mm		1-5/8"		9-1/4" x 3/8"	M4
246-288-__	28	288 mm		1-5/8"		11-3/4" x 3/8"	M4
246-384-__	28	384 mm		1-5/8"		15-1/2" x 3/8"	M4
247-096-__	30	96 mm cc		1-1/16"	1/4"	5-3/8"	M4
247-128-__	30	128/160 mm		1-1/16"	1/4"	7-15/16"	M4
247-192-__	30	192/224 mm		1-1/16"	1/4"	10-1/2"	M4
247-320-__	30	320/352 mm		1-1/16"	1/4"	16-1/2"	M4
248-096-__	30	96/128 mm		1-1/16"	3/16"	5-3/8"	M4
248-160-__	30	160/192 mm		1-1/16"	3/16"	7-7/8"	M4
248-288-__	30	288/320 mm		1-1/16"	3/16"	12-15/16"	M4
248-448-__	30	448/480 mm		1-1/16"	3/16"	19-3/16"	M4
250-__	15		1-3/8"	1"	3/4"		#8-32
251-__	15		1-1/2"	1-1/8"	3/4"		#8-32
252-__	15		1-1/4"	1-1/8"	3/4"	3/4" x 1-1/4"	#8-32
253-__	15		2-7/8"	1-1/2"	3/4"	3/4" x 2-7/8"	#8-32
254-__	15	3"		1"		1-3/4" x 4-3/4"	#8-32
255-__	15	96 mm		1-3/8"	5/8"	4-3/8"	#8-32
256-__	15	8"		1-3/8"	5/8"	8-3/4"	#8-32
257-__	15	12"		1-3/4"	7/8"	12-3/4"	1/4-20
258-__	15	5"		1-1/4"	1-1/4"	6-1/4"	#8-32
260-__	51		1-5/16"	1"	3/4"		#8-32
261-__	51		1-7/8"	1"	5/8"	7/8" x 1-7/8"	#8-32
262-__	51	96 mm		7/8"	7/8" x 1/2"	6-1/2"	#8-32
263-__	51	8"		1-3/8"	2-1/4" x 1-1/4"	11-3/4"	1/4-20

INDEX

PART #	PAGE #	PULL CENTER TO CENTER	KNOB DIAMETER	PROJECTION	BASE DIAMETER	OVERALL	SCREW SIZE
264-__	51	12"		1-3/4"	2-1/2" x 1-1/4"	16-1/2"	1/4-20
265-__	51	3"		1-1/8"		2" x 4-3/4"	#8-32
280-__	58	96/128 mm		7/8"	5/16"	6-1/8"	M4
281-__	58	96 mm cc		7/8"	5/16"	4-7/16" x 1-1/8"	M4
282-__	58	96 mm cc		9/16"	5/16"	4-11/16" x 1-1/2"	M4
283-__	58		1-1/8"	15/16"	1/2"		M4
284-__	58	128 mm cc		1-3/8"	11/16"	5-11/16"	M4
290-__	41		1-1/8"	1-3/16"	1/4"		#8-32
291-__	41	4"		1-3/16"	3/8"	5-3/4"	#8-32
299-__	25		1/2" x 1/2"	1"	3/8"		M4
300-__	25		1/2" x 1/2"	1"	3/8"		M4
301-__	25	32 mm		1"	1/4"	2-1/2"	M4
302-__	25	128/160 mm		1-1/8"	1-1/8"	7-1/2"	M4
303-__	25	288/320 mm		1-3/8"	1-3/8"	13-3/8"	M4
304-__	25	32 mm		1"	1-1/4"	2-1/2"	M4
305-__	25	128/160 mm		1-1/8"	1-1/8"	7-1/2"	M4
306-__	25	288/320 mm		1-3/8"	1-3/8"	13-3/8"	M4
307-__	34	32 mm		1-1/4"	2-1/2"	6-3/8"	M4
308-__	34	96/128 mm		1"	1"	5-1/2"	M4
309-__	34	160/192 mm		1-1/8"	1-1/2"	8-1/4"	M4
310-__	34	288/320 mm		1-1/8"	2-1/2"	13-3/8"	M4
311-__	34	448/480 mm		1-1/4"	4"	19-5/8"	M4
312-__	34	96/128 mm		1"	1"	5-3/8"	M4
313-__	34	160/192 mm		1"	1"	7-7/8"	M4
314-__	34	288/320 mm		1"	1"	13"	M4
315-__	18	64 mm		1"	1/2"	2-7/8"	M4
316-__	18	128 mm		1"	1/2"	5-3/8" x 1"	M4
317-__	18	160 mm		1"	1/2"	6-5/8" x 1"	M4
318-__	18	320 mm		1"	1/2"	13" x 1"	M4
319-__	18	16 mm cc	1-1/4" x 1-1/2"	1"	1-1/4"	1-1/4" x 1-1/2"	M4
320-__	18	128 mm cc		1"	1/2"	5-3/8" x 1"	M4
321-__	18	160 mm cc		1"	1/2"	6-5/8" x 1"	M4
322-__	18	224 mm cc		1"	1/2"	9-1/4" x 1"	M4
323-__	19	32 mm cc		1-3/4"	2-1/2" x 1/2"	2-1/2" x 1-3/4"	#5
324-__	19	128 mm cc		1-3/4"	6-1/4" x 1/2"	6-1/4" x 1-3/4"	#5
360-__	29		1-3/8"	7/8"	3/8"		M4
361-__	29	32 mm		1"	1-1/2" x 1/4"	4-3/4"	M4
362-__	29	64 mm		7/8"	3/4" x 1/4"	3-1/2"	M4
363-__	29	128 mm		1"	1" x 1/4"	6-1/2"	M4
364-__	29	160/192 mm		1"	1-1/2" x 1/4"	9-1/4"	M4
365-__	29	288/320 mm		1-1/8"	1-1/2" x 1/4"	14-1/4"	M4
370-__	31	128 mm		1-1/8"	3/8" x 5/16"	7-1/4"	M4

INDEX

PART #	PAGE #	PULL CENTER TO CENTER	KNOB DIAMETER	PROJECTION	BASE DIAMETER	OVERALL	SCREW SIZE
371-__	31	224 mm		1-1/8"	3/8" x 5/16"	11-1/8"	M4
372-__	31	288 mm		1-1/8"	3/8" x 5/16"	13-5/8"	M4
373-__	31	320 mm		1-1/8"	3/8" x 5/16"	14-7/8"	M4
401-__	17		2"	1-1/4"	7/8"	2"	#8-32
404-__	17	4"		1-1/4"	7/8"	6"	#8-32
406-__	17	6"		1-1/4"	7/8"	8"	#8-32
408-__	17	8"		1-1/4"	7/8"	10"	#8-32
440-__	26	32 mm		3/4"		2-3/4" x 2-3/4"	M4
441-__	26	64 mm		3/4"		3-1/2" x 2-1/8"	M4
442-__	26	160 mm		3/4"		7" x 2-1/8"	M4
443-__	26	64 mm		7/8"		3-1/2" x 3-1/2"	M4
444-__	26	96 mm		7/8"		4-5/8" x 2-1/8"	M4
445-__	26	128 mm		7/8"		5-7/8" x 2-1/8"	M4
446-__	26	192 mm		7/8"		8-1/2" x 2-1/8"	M4
450-__	26	32 mm		7/8"		2-1/4" x 2-1/4"	M4
451-__	26	160 mm		7/8"		7" x 1-3/4"	M4
501-__	27	4"		1-1/8"	3/8"	4-1/4"	#8-32
502-__	27	6"		1-1/8"	3/8"	6-3/16"	#8-32
503A-__	27	13-3/4"		2-1/8"	1"	14-3/8"	M6
511-__	27	4"		1-3/16"	3/8"	4-3/16"	#8-32
512-__	27	6"		1-3/16"	3/8"	6-1/4"	#8-32
513A-__	27	13-3/4"		2-3/4"	1"	14-1/2"	M6
530-__	39		1-1/4"	1"	3/4"		#8-32
531-__	39		1-1/4"	1"	3/4"		#8-32
532-__	39		1-1/4"	1-1/8"	3/4"		#8-32
533-__	39		1-1/4"	1-1/8"	1"		#8-32
534-__	39	3-1/2"		1-1/4"		4-1/2"	#8-32
535-__	39	15"		2"	1-1/4"	16-1/2"	1/4-20
536-__	39	8"		1-1/8"	1"	8-3/4"	#8-32
537-__	39	6"		1-1/8"	3/4"	6-3/4"	#8-32
538-__	39	4"		1-1/8"	3/4"	4-3/4"	#8-32
539-__	39	15"		2"	1-1/8"	16-1/8"	1/4-20
540-__	39	8"		1"	3/4"	8-1/2"	#8-32
541-__	39	6"		1"	1/2"	6-1/2"	#8-32
542-__	39	4"		1"	1/2"	4-1/2"	#8-32
570-__	43		1-1/4"	1-1/8"	3/4"		#8-32
571-__	43		1-1/4"	1-1/8"	3/4"		#8-32
572-__	43		1-1/4"	1-1/8"	3/4"		#8-32
573-__	43	3"		1-1/2"		4-1/2" x 2"	#8-32
574-__	43	3"		1-1/2"		4-1/2" x 2"	#8-32
575-__	43	3"		1-1/2"		4-1/2" x 2"	#8-32

INDEX

PART #	PAGE #	PULL CENTER TO CENTER	KNOB DIAMETER	PROJECTION	BASE DIAMETER	OVERALL	SCREW SIZE
576-__	43	4"		1-1/4"	1-1/4" w/o plate 1/2"	4-1/2"	#8-32
577-__	43	8"		1-1/2"	1-1/4" w/o plate 1/2"	8-1/2"	#8-32
578-__	43	15"		2"	1-1/2" w/o plate 5/8"	15-3/4"	1/4-20
579-__	43	4"		1-1/4"	1-1/4" w/o plate 1/2"	4-1/2"	#8-32
580-__	43	8"		1-1/2"	1-1/4" w/o plate 1/2"	8-1/2"	#8-32
581-__	43	15"		2"	1-1/2" w/o plate 5/8"	15-3/4"	1/4-20
703-__	44,45,47		1-1/4"	7/8"	3/4"		#8-32
704-__	44,45,47		1-1/2"	1"	1"		#8-32
706-__	44,45,46		1-1/4"	1"	3/4"		#8-32
711-__	44,45,46		1-1/4"	7/8"	5/8"		#8-32
719-__	44,45,46		1-3/8"	1-1/4"	1/2"		#8-32
721-__	44,45	3"		7/8"	3/8"	3-3/8"	#8-32
730-__	44,45	3"		1"		3-3/4" x 1-1/4"	#8-32
731-__	44,45	3"		1"		4-5/8" x 1-3/8"	#8-32
732-__	44,45	4"		1-1/8"	3/8"	4-3/8"	#8-32
737-__	44,45	6"		1-1/4"	1/2"	6-3/8"	#8-32
738-__	44,45	15"		2-1/4"	3/4"	15-1/2"	1/4-20
739-__	44,45	10"		2-1/8"	7/8" x 5/8"	10-1/2"	1/4-20
742-__	46	4"		1-1/8"	1" x 7/8"	5-1/8"	#8-32
743-__	46	3"		3/4"		3-3/4" x 1"	#8-32
744-__	46	6"		3/4"		6 5/8" x 1"	#8-32
745-__	46	6"		1-1/4"	1-1/8"	7-1/2"	#8-32
746-__	46	12"		1-13/16"	1-13/16"	14-1/4"	1/4-20
7465-__	46	15"		1-3/4"	1-3/4" x 1-3/8"	17-1/2"	1/4-20
747-__	47	4"		1-3/16"	7/16"	4-5/16"	#8-32
748-__	47	6"		1-7/8"	3/4"	6-5/8"	#8-32
749-__	47	12"		2-1/4"	7/8"	12-7/8"	1/4-20
7495-__	47	15"		2-1/4"	7/8"	16"	1/4-20
751-__	54		1-1/4"	1"	1/2"		#8-32
752-__	54		1-1/2"	1-1/4"	5/8"		#8-32
753-__	54	3"		1-1/8"	3/4" x 3/8"	4-1/8"	#8-32
754-__	54	3-1/2"		1-1/8"	3/4" x 3/8"	4-1/2"	#8-32
756-__	54			1/8"	1-1/2"		#8-32
761-__	54			1/8"		4-1/4" x 1"	#8-32
762-__	54	96 mm		1-1/8"	1/2"	4-1/4"	#8-32
763-__	54	96 mm		1/8"		7-3/16" x 1"	#8-32
764-__	54	10"		2-1/2"	7/8"	10-3/4"	1/4-20
765-__	7		1"	15/16"	1/2"		#8-32
768-__	9		2"	1-3/8"	1/2"		#8-32
771-__	8		1-1/4"	1-1/8"	1/2"		#8-32
772-__	8,13		1-3/8"	1-1/4"	5/8"		#8-32
773-__	8,13		1-5/8"	1-1/4"	5/8"		#8-32

INDEX

PART #	PAGE #	PULL CENTER TO CENTER	KNOB DIAMETER	PROJECTION	BASE DIAMETER	OVERALL	SCREW SIZE
775-__	8,13	3-1/2"		1"		4-1/8" x 1-3/4"	#8-32
776-__	14		1-3/4"	1-1/8"	3/4"		#8-32
777-__	8,13	4"		1-1/4"	1" x 3/4"	5"	#8-32
778-__	8,13	6"		1-1/4"	1-1/8" x 7/8"	7-1/4"	#8-32
779-__	8,13	12"		1-5/8"	1-1/8" x 7/8"	13"	1/4-20
780-__	8,13	18"		1-3/4"	1-1/2" x 1-1/8"	19-3/8"	1/4-20
781-__	8,14		1-3/8"	1-3/8"	5/8"		#8-32
782-__	8,14		1-7/8"	1-1/4"	5/8"	1-7/8" x 1"	#8-32
783-__	9	4"		1-1/2"	3/8"	6"	#8-32
784-__	9	6"		1-3/4"	3/8"	7-1/4"	#8-32
785-__	9	12"		2-1/8"	5/8"	15-5/8"	1/4-20
787-5-__	14	5"		1-3/8"	1/2" x 3/4"	5-7/8" x 7/8"	#8-32
787-10-__	14	10"		1-1/2"	5/8" x 7/8"	10-15/16" x 15/16"	1/4-20
787-18-__	14	18"		1-3/4"	3/4" x 1"	19" x 1-3/16"	1/4-20
787-96-__	14	96 mm		1"	3/8"	4-1/2"	#8-32
787-128-__	14	128 mm		1-1/4"	3/8"	5-3/8"	#8-32
788-4-__	7	4"		1-1/8"	5/16"	4-5/16"	#8-32
788-6-__	7	6"		1-1/4"	3/8"	6-5/16"	#8-32
788-12-__	7	12"		1-1/2"	7/16"	12-1/2"	1/4-20
788-18-__	7	18"		1-9/16"	1/2"	18-5/8"	1/4-20
788-18A-__	7	18"		2"	5/8"	18-3/4"	1/4-20
789-__	7		1-1/4"	1-1/4"	1/2"		#8-32
790-__	53		1-3/8"	1-1/4"	7/8"		#8-32
791-__	53	96 mm		1-1/8"	1" x 5/8"	5-1/2"	#8-32
793-__	53	3"		1"		4-1/8" x 2"	#8-32
794-__	53		1-3/8"	1-1/8"	3/4"		#8-32
795-__	53			1/4"	1-1/2"		#8-32
796-__	53			1-1/8"	3/4"	1-1/2" x 1"	#8-32
797-__	53	96 mm		1-1/8"	1/2"	4-1/2"	#8-32
800-__	52		1-3/8"	1-1/4"	1/2"		#8-32
801-__	52	96 mm		1-3/8"	5/8"	4-3/8"	#8-32
802-__	52	15"		3-1/16"	1-1/4"	16-1/4"	1/4-20
803-__	52	6"		1-3/8"	5/8"	7-5/8"	#8-32
805-__	14		1-1/4"	1"	1/2" x 1/4"		#8-32
808-__	14		1-1/4" x 1"	7/8"	1/2" x 1/4"		#8-32
809-__	14		1-1/4"	3/4"	1/2" x 1/4"		#8-32
810-__	7		1-1/4" x 1-1/4"	1"	1/2" x 1/4"		#8-32
814-__	7		1-1/4" x 7/8"	7/8"	1/2" x 1-1/4"		#8-32
815-__	7		1-3/4" x 1-3/4"	1-1/4"	1/2"		#8-32
816-__	7	96 mm		1"	6" x 1-1/4"	6" x 1-1/4"	#8-32
830-__	55		1-3/8"	1-1/4"	1/2"		#8-32
831-__	55			1-1/4"	1/2"	1-3/4" x 7/8"	#8-32

INDEX

PART #	PAGE #	PULL CENTER TO CENTER	KNOB DIAMETER	PROJECTION	BASE DIAMETER	OVERALL	SCREW SIZE
832-__	55			1/8"		4-1/4" x 7/8"	#8-32
833-__	55	96 mm		1-1/4"	3/4"	4-3/4"	#8-32
834-__	55	3"		1-1/4"		3-3/4" x 1-5/8"	#8-32
835-__	55	15"		2-1/2"	1-1/4"	15-3/4"	1/4-20
836-__	55	6"		1-1/4"	3/4"	7"	#8-32
868-__	57	15"		2-1/8"	2-3/4" x 2"	18-5/8"	1/4-20
869-__	56	15"		1-7/8"	2-3/8" x 1-7/8"	17-1/4"	1/4-20
870-__	57		1-3/8"	1-1/4"	1"		#8-32
871-__	57	96 mm		1"	1-1/2"	6-1/2"	#8-32
8716-__	57	6"		1-1/4"	1-5/8"	8-3/4"	#8-32
872-__	57	3"		1"		4-3/4" x 1-3/4"	#8-32
873-__	56		1-3/8"	1-1/8"	7/8"		#8-32
874-__	56	96 mm		1-1/8"	1-1/4"	5-3/4"	#8-32
8746-__	56	6"		1-1/8"	1-1/4"	8"	#8-32
875-__	56	3"		1"		4-1/4" x 1-3/4"	#8-32
876-__	40		1-3/8"	1-1/8"	1"		#8-32
877-__	40	4"		1-1/4"	7/8"	4-7/8"	#8-32
878-__	40	3"		1-1/4"		4-3/8" x 1-7/8"	#8-32
879-__	40	8"		1-1/4"	7/8"	8-7/8"	#8-32
880-__	40	12"		1-5/8"	1-1/8"	13-1/8"	1/4-20
881-__	40	15"		1-7/8"	1-3/16"	16"	1/4-20
882-__	40		1-3/8"	1-1/8"	1"		#8-32
SS 010	35		3/4"	1-1/8"	3/4"		#8-32
SS 012	35		1-1/8"	7/8"	3/4"		#8-32
SS 014	35		1/2"	1-3/8"	1/2"	1-3/8"	#8-32
SS 096	35	96 mm		1-3/8"	1/2"	6-1/8"	#8-32
SS 128	35	128 mm		1-3/8"	1/2"	7-3/8"	#8-32
SS 160	35	160 mm		1-3/8"	1/2"	8-5/8"	#8-32
SS 224	35	224 mm		1-3/8"	1/2"	11-1/8"	#8-32
SS 288	35	288 mm		1-3/8"	1/2"	13-3/4"	#8-32
SS 384	35	384 mm		1-3/8"	1/2"	17-1/2"	#8-32
SS 448	35	448 mm		1-3/8"	1/2"	20"	#8-32
SS 544	35	544 mm		1-3/8"	1/2"	23-3/4"	#8-32
SS 640	35	640 mm		1-3/8"	1/2"	27-1/2"	#8-32
SS 736	35	736 mm		1-3/8"	1/2"	31-3/8"	#8-32
SS 832	35	832 mm		1-3/8"	1/2"	35-1/8"	#8-32
SS BOW 096	35	96 mm		1-1/8"	3/8" x 1/2"	4-1/2"	#8-32
SS BOW 128	35	128 mm		1-1/8"	3/8" x 5/8"	6-1/8"	#8-32
SS BOW 224	35	224 mm		1-1/8"	3/8" x 1"	10-1/4"	#8-32
SS BOW 288	35	288 mm		1-1/8"	3/8" x 1-1/8"	13-1/4"	#8-32

ASSA ABLOY is the global leader in door opening solutions, dedicated to satisfying end-user needs for security, safety and convenience



Schaub
ASSA ABLOY

4740 Talon Ct SE, Ste 4
Grand Rapids, Michigan 49512

Phone: 616.871.0040
Fax: 616.871.0058

schaubandcompany.com

