

JEFFREY ALEXANDER[®]
by Hardware Resources

E L E M E N T S[®]
by Hardware Resources



*Decorative Hardware
Collections 2019*

JEFFREY ALEXANDER®

by Hardware Resources



A step above...

Quality, Selection, & Designs

Design Details

50+ Patented and original collections plus industry standard designs in a wide variety of styles including Traditional, Transitional and Modern/Contemporary.

Heavier in Weight

Our designs have solid or flat backs, providing a comfortable feel in your hand.

Made from Quality Materials

Zinc/Zamak Alloy – A Zinc alloy that contains approximately 4% aluminum which provides excellent die castability and strength, resulting in a durable, corrosion-resistant product. Zinc is also a clean and recyclable material, making it eco-friendly.

Steel – durable and resistant to corrosion, providing a superior product.

Lifetime Warranty

Hardware Resources believes in quality, integrity and reliability by offering a lifetime warranty on all of our Jeffrey Alexander decorative hardware (see page 180).

Contents

Jeffrey Alexander Collections

Aberdeen.....	5
Alvar	6
Amsden.....	7
Annadale	8
Anwick.....	9
Backplates	77
Belcastel 1	10-11
Belcastel 2	12
Bella	13
Bienville.....	14
Bordeaux	15
Boswell NEW	16
Brighton.....	17
Bremen 1	18-19
Bremen 2	20
Cairo	21
Callie.....	22
Chesapeake	23
Cordova.....	24
Delgado	25
Delmar.....	26
Durham	27
Duval.....	28
Elara NEW	29
Ella.....	30
Encada.....	31
Evangeline.....	32
Finial Hinges.....	78
Glenmore.....	33
Harlow	34
Hayworth.....	35
Hudson.....	36
Katharine.....	37
Key Grande.....	38
Key West & Key Largo.....	39
Kensington.....	40
Lafayette.....	41
Latches	78
Lenoir.....	42
Lexa.....	43
Leyton.....	44
Lille.....	45
Lyon	46
Marlo.....	47
Maybeck.....	48
Merrick.....	49
Milan 1	50
Milan 2	51
Mirada.....	52
Modena.....	53
Montclair.....	54
Odessa	55
Padua	56
Prestige	57
Pull Escutcheons.....	76
Rae	58

Regan.....	59
Regency	60
Rhodes.....	61
Rochester.....	62
Royce.....	63
Solana.....	64
Sonoma.....	65
Sullivan NEW	66
Sutton	67
Symphony.....	68
Tahoe.....	69
Tiffany.....	70
Tuscany.....	71
Valencia.....	72
Venezia.....	73
Zane.....	74
Zurich.....	75

Elements Collections

Aiden.....	80
Arcadia	81
Asher	82
Belfast	83
Brenton.....	84
Calloway.....	85
Capri.....	86
Cosgrove.....	87
Cypress	88
Drake.....	89
Edgefield.....	90
Florence	91
Gatsby	92
Geneva	93
Glendale	94
Hadly.....	95
Hammond.....	96
Kenner	97
Kingsport.....	98
Lindos	99
Luxe	100
Madison	101
Naples.....	102-103
Merryville.....	104
Park	105
Seaver	106
Sedona	107
Slade	108
Somerset	109
Stanton.....	110
Strickland	111
Syracuse	112
Torino	113
Verona.....	114
Vienna.....	115
Watervale.....	116
Westbury	117
Zachary.....	118

Available Finishes

	AB <i>Brushed Antique Brass</i>		BNB <i>Brushed Black Nickel</i>		ORB <i>Dark Bronze</i>
	ABM/ABM-D <i>Distressed Antique Brass</i>		BNBDL <i>Brushed Pewter</i>		PB <i>Polished Brass</i>
	ABSB <i>Antique Brushed Satin Brass</i>		BNMDL/BNDL <i>Distressed Pewter</i>		PC <i>Polished Chrome</i>
	AE <i>Antique Brass</i>		BLK <i>Black (Tahoe only)</i>		SB <i>Satin Brass</i>
	AEM <i>Lightly Distressed Antique Brass</i>		DACM <i>Gun Metal</i>		SBN <i>Satin Black Nickel</i>
	AL <i>Aluminum</i>		DBAC <i>Brushed Oil Rubbed Bronze</i>		NEW SBZ <i>Satin Bronze</i>
	ALM <i>Almond</i>		DP <i>Distressed Pewter</i>		SIM/SIM-D <i>Distressed Antique Silver</i>
	ASM <i>Distressed Antique Silver</i>		DMAC <i>Distressed Oil Rubbed Bronze</i>		SN <i>Satin Nickel</i>
	BB <i>Brushed Brass</i>		DN <i>Dull Nickel</i>		SS <i>Stainless Steel</i>
	BC <i>Brushed Chrome</i>		MB/BLK <i>Matte Black</i>		WH <i>White</i>
	NEW BG <i>Brushed Gold</i>		MS <i>Matte Silver</i>		
	BN <i>Black Nickel</i>		NI <i>Polished Nickel</i>		

All brushed and machined finishes are created by hand to add texture to the item. We hold a tight range of acceptance of color variation, however, a slight variance in the texture and tone of these items occur. We consider these variances to be minimal; slight variations are normal.

JEFFREY ALEXANDER®

by Hardware Resources

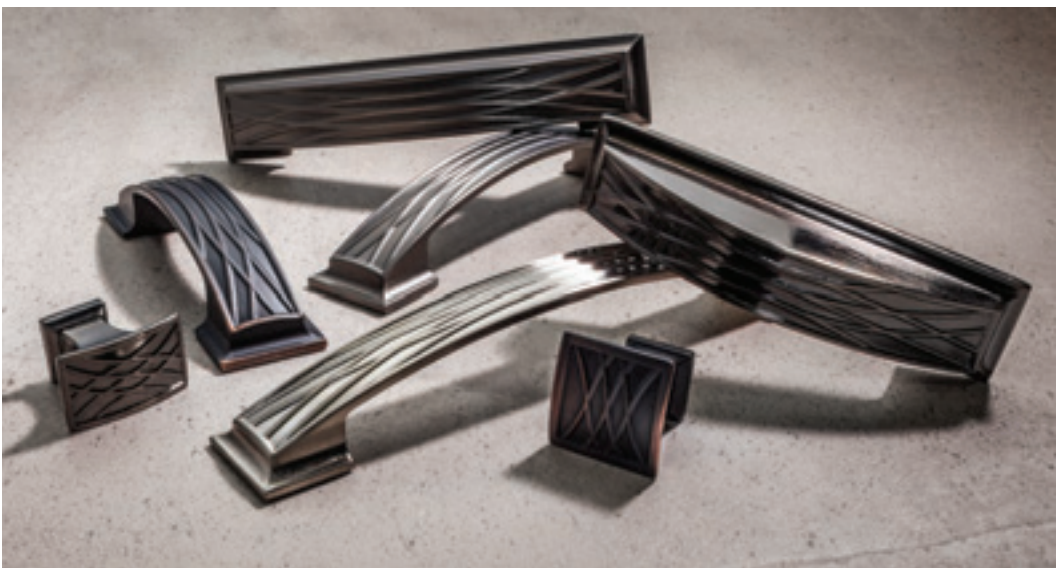

Aberdeen

US Patent # D708,927; D707,098; D722,483; D710,674

Item	Description	Overall Length or Diameter	Ctn Qty	Finishes	List (each)
535	square knob	1-1/4"	20	BNB, BNBDL, DBAC, SN	\$10.50
535L	oblong knob	1-1/2"	20	BNB, BNBDL, DBAC, SN	\$10.50
535-96	96 mm (3-3/4") CC	5"	10	BNB, BNBDL, DBAC, SN	\$18.55
536-96	96 mm (3-3/4") CC cup pull	5"	10	BNB, BNBDL, DBAC, SN	\$20.89
535-128	128 mm (5-1/16") CC	6-1/4"	10	BNB, BNBDL, DBAC, SN	\$25.75
536-128	128 mm (5-1/16") CC cup pull	6-1/4"	10	BNB, BNBDL, DBAC, SN	\$30.45
535-160	160 mm (6-5/16") CC	7-5/8"	10	BNB, BNBDL, DBAC, SN	\$31.68



BNB
Brushed
Black Nickel



BNBDL
Brushed
Pewter



DBAC
Brushed Oil
Rubbed Bronze



SN
Satin Nickel

JEFFREY ALEXANDER®

by Hardware Resources



Alvar

New finish

Item	Description	Overall Length or Diameter	Ctn Qty	Finishes	List (each)
264-3	3" CC	3-11/16"	20	BNBDL, DBAC, NI, PC, SBZ, SN	\$7.45
264-96	96 mm (3-3/4") CC	4-7/16"	20	BNBDL, DBAC, NI, PC, SBZ, SN	\$8.35
264-128	128 mm (5-1/16") CC	5-3/4"	20	BNBDL, DBAC, NI, PC, SBZ, SN	\$9.68
264-160	160 mm (6-5/16") CC	7"	10	BNBDL, DBAC, NI, PC, SBZ, SN	\$11.98
264-192	192 mm (7-9/16") CC	8-1/4"	10	BNBDL, DBAC, NI, PC, SBZ, SN	\$14.35



BNBDL
Brushed Pewter



DBAC
Brushed Oil
Rubbed Bronze



NI
Polished
Nickel



PC
Polished
Chrome



SBZ
Satin Bronze
NEW



SN
Satin Nickel

JEFFREY ALEXANDER®

by Hardware Resources



Amsden

Item	Description	Overall Length or Diameter	Ctn Qty	Finishes	List (each)
613 [‡]	small knob	1-7/16"	25	DBAC, DMAC, DP, NI, SN	\$7.75
613L [‡]	large knob	1-5/8"	20	DBAC, DMAC, DP, NI, SN	\$10.71
613-96 [‡]	96 mm (3-3/4") CC	4-3/8"	15	DBAC, DMAC, DP, NI, SN	\$9.31
613-128 [‡]	128 mm (5-1/16") CC	5-5/8"	10	DBAC, DMAC, DP, NI, SN	\$15.38
613-160 [‡]	160 mm (6-5/16") CC	6-7/8"	10	DBAC, DMAC, DP, NI, SN	\$19.86



DBAC
Brushed Oil
Rubbed Bronze

DMAC
Distressed Oil
Rubbed Bronze

DP
Distressed
Pewter

NI
Polished Nickel

SN
Satin Nickel



These products are being retired.
Call for availability on products marked with "‡".

JEFFREY ALEXANDER®

by Hardware Resources



Annadale

US Patent # D708,040; D708,926; D721,941; D711,722

New finish

Item	Description	Overall Length or Diameter	Ctn Qty	Finishes	List (each)
435	square knob	1-1/4"	20	BNBDL, DACM, DBAC, MB, SN	\$10.05
435L	oblong knob	1-1/2"	20	BNBDL, DACM, DBAC, MB, SN	\$10.05
435-96	96 mm (3-3/4") CC	5"	10	BNBDL, DACM, DBAC, MB, SN	\$14.97
436-96	96 mm (3-3/4") CC cup pull	5"	10	BNBDL, DACM, DBAC, MB, SN	\$18.55
435-128	128 mm (5-1/16") CC	6-1/4"	10	BNBDL, DACM, DBAC, MB, SN	\$23.35
436-128	128 mm (5-1/16") CC cup pull	6-1/4"	10	BNBDL, DACM, DBAC, MB, SN	\$28.15
435-160	160 mm (6-5/16") CC	7-5/8"	10	BNBDL, DACM, DBAC, MB, SN	\$29.29



BNBDL
Brushed Pewter

DACM
Gun Metal

DBAC
Brushed Oil
Rubbed Bronze

MB
Matte Black
NEW

SN
Satin Nickel

JEFFREY ALEXANDER®

by Hardware Resources



Anwick

US Patent # D728,342; D737,654

Item	Description	Overall Length or Diameter	Ctn Qty	Finishes	List (each)
867	oblong knob	1-3/8"	30	BNBDL, DBAC, NI, SN	\$9.21
867L	square knob	1-1/8"	20	BNBDL, DBAC, NI, SN	\$9.53
867-3	3" CC	4-5/16"	10	BNBDL, DBAC, NI, SN	\$11.31
867-96	96 mm (3-3/4") CC	5-1/8"	10	BNBDL, DBAC, NI, SN	\$14.35
867-128	128 mm (5-1/16") CC	6-3/8"	10	BNBDL, DBAC, NI, SN	\$19.95
867-160	160 mm (6-5/16") CC	7-5/8"	10	BNBDL, DBAC, NI, SN	\$22.59
867-228	228 mm (9") CC	10-5/16"	10	BNBDL, DBAC, NI, SN	\$32.25
867-320	320 mm (12-5/8") CC	13-15/16"	10	BNBDL, DBAC, NI, SN	\$55.75



JEFFREY ALEXANDER®

by Hardware Resources



Belcastel 1 - Contemporary Finishes

New finish

Item	Description	Overall Length or Diameter	Ctn Qty	Finishes	List (each)
MO6303	knob	1-3/8"	20	BNBDL, DBAC, NI, PC, SBZ, SN	\$7.40
MO6373	96 mm (3-3/4") CC	4-5/8"	15	BNBDL, DBAC, NI, PC, SBZ, SN	\$9.25
MO6373-128	128 mm (5-1/16") CC	5-7/8"	20	BNBDL, DBAC, NI, PC, SBZ, SN	\$12.10
MO6373-160	160 mm (6-5/16") CC	7-1/8"	10	BNBDL, DBAC, NI, PC, SBZ, SN	\$14.55
MO6373-12	12" CC appliance pull	13-1/4"	5	BNBDL, DBAC, NI, PC, SBZ, SN	\$131.00
MO6373-18	18" CC appliance pull	19-1/4"	5	BNBDL, DBAC, NI, PC, SBZ, SN	\$165.00



Switching from 3" CC to 96 mm?
Use Pull Escutcheons to cover the old holes
See PE07 on page 148



Belcastel 1 - Traditional Finishes

Item	Description	Overall Length or Diameter	Ctn Qty	Finishes	List (each)
MO6303	knob	1-3/8"	20	ABM-D, DACM, DMAC, SIM-D	\$7.40
MO6373	96 mm (3-3/4") CC	4-5/8"	15	ABM-D, DACM, DMAC, SIM-D	\$9.25
MO6373-128	128 mm (5-1/16") CC	5-7/8"	20	ABM-D, DACM, DMAC, SIM-D	\$12.10
MO6373-160	160 mm (6-5/16") CC	7-1/8"	10	ABM-D, DACM, DMAC, SIM-D	\$14.55
MO6373-12	12" CC appliance pull	13-1/4"	5	ABM-D, DACM, DMAC, SIM-D	\$131.00
MO6373-18	18" CC appliance pull	19-1/4"	5	ABM-D, DACM, DMAC, SIM-D	\$165.00



**Switching from
3" CC to 96 mm?**
Use Pull Escutcheons
to cover the old holes
See PE07 on page 148

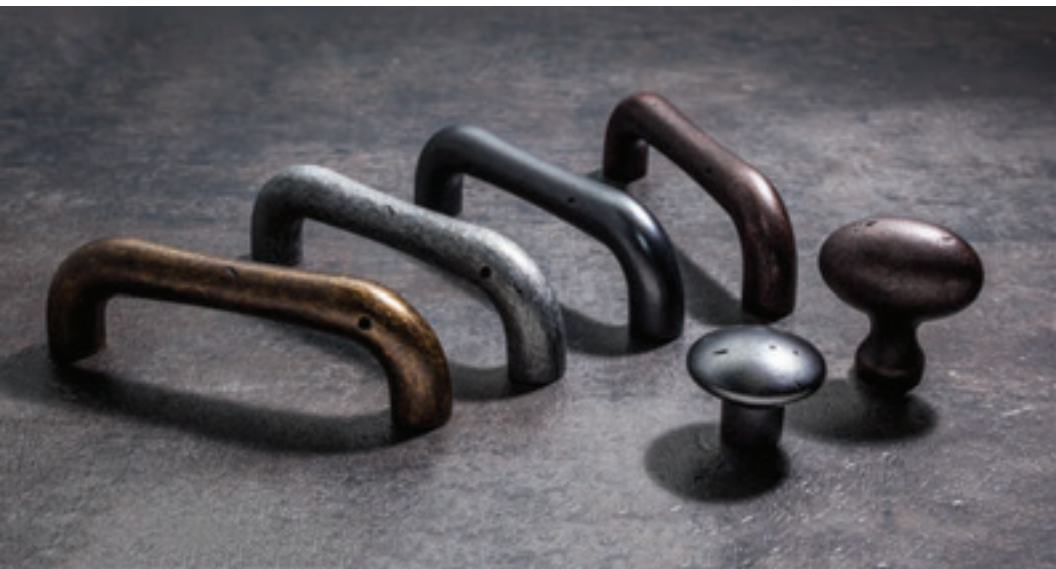

Belcastel 2

Item	Description	Overall Length or Diameter	Ctn Qty	Finishes	List (each)
MO6203 [†]	round knob	1-1/4"	20	ABM-D, DACM, DMAC, SIM-D	\$6.95
MO6313 [†]	egg knob	1-9/16"	15	ABM-D, DACM, DMAC, SIM-D	\$10.71
MO6273 [†]	96 mm (3-3/4") CC	4-1/4"	10	ABM-D, DACM, DMAC, SIM-D	\$9.99



**Switching from
3" CC to 96 mm?**
Use Pull Escutcheons
to cover the old holes
See PE07 on page 148



JEFFREY ALEXANDER®

by Hardware Resources



Bella

US Patent # D662,388; D661,972; D660,679

Item	Description	Overall Length or Diameter	Ctn Qty	Finishes	List (each)
818	round knob	1-3/8"	20	ABSB, BNBDL, DBAC, NI, SN	\$11.81
818L	T knob	2-1/4"	20	ABSB, BNBDL, DBAC, NI, SN	\$15.55
818-96	96 mm (3-3/4") CC	4-3/8"	15	ABSB, BNBDL, DBAC, NI, SN	\$18.35
818-128	128 mm (5-1/16") CC	5-11/16"	15	ABSB, BNBDL, DBAC, NI, SN	\$21.10
818-160	160 mm (6-5/16") CC	6-15/16"	10	ABSB, BNBDL, DBAC, NI, SN	\$26.95
818-12	12" CC appliance pull	13-1/8"	5	ABSB, BNBDL, DBAC, NI, SN	\$141.00



Switching from 3" CC to 96 mm?
Use Pull Escutcheons to cover the old holes
See PE07 on page 148

JEFFREY ALEXANDER®

by Hardware Resources



Bienville

US Patent # D602,336; D595,107

Item	Description	Overall Length or Diameter	Ctn Qty	Finishes	List (each)
959	knob	1-5/16"	30	ABSB, BNBDL, DBAC	\$9.75
959-96	96 mm (3-3/4") CC	5-13/16"	20	ABSB, BNBDL, DBAC	\$13.89



ABSB
Antique Brushed
Satin Brass



BNBDL
Brushed Pewter



DBAC
Brushed Oil
Rubbed Bronze

*Switching from
3" CC to 96 mm?*
Use Pull Escutcheons
to cover the old holes
See PE07 on page 148



Bordeaux

Item	Description	Overall Length or Diameter	Ctn Qty	Finishes	List (each)
3990	egg knob	1-3/16"	25	AB, BLK, BNBDL, DACM, DBAC, NI, ORB, PC, SIM, SN	\$6.85
8236	96 mm (3-3/4") CC	5"	25	AB, BLK, BNBDL, DACM, DBAC, NI, ORB, PC, SIM, SN	\$8.27



AB
Brushed
Antique Brass

BLK
Matte Black

BNBDL
Brushed Pewter

DACM
Gun Metal

DBAC
Brushed Oil
Rubbed Bronze



NI
Polished
Nickel

ORB
Dark Bronze

PC
Polished
Chrome

SIM
Distressed
Antique Silver

SN
Satin Nickel



Boswell

New Collection

Item	Description	Overall Length or Diameter	Ctn Qty	Finishes	List (each)
177-96	96 mm (3-3/4") CC	4-1/4"	15	BNBDL, DBAC, MB, PC, SN	\$8.15
177-128	128 mm (5-1/16") CC	5-9/16"	15	BNBDL, DBAC, MB, PC, SN	\$10.71
177-160	160 mm (6-5/16") CC	6-13/16"	10	BNBDL, DBAC, MB, PC, SN	\$13.40
177-192	192 mm (7-9/16") CC	8-1/16"	10	BNBDL, DBAC, MB, PC, SN	\$16.11
177-224	224 mm (8-7/8") CC	9-5/16"	10	BNBDL, DBAC, MB, PC, SN	\$18.85



BNBDL
Brushed Pewter



DBAC
Brushed Oil
Rubbed Bronze



MB
Matte Black



PC
Polished Chrome



SN
Satin Nickel

JEFFREY ALEXANDER®

by Hardware Resources



Brighton

US Patent # D602,331; D598,268

Item	Description	Overall Length or Diameter	Ctn Qty	Finishes	List (each)
874	knob	1-7/16"	30	ABSB, BNBDL, DBAC, SN	\$8.09
874-96	96 mm (3-3/4") CC	6-3/16"	15	ABSB, BNBDL, DBAC, SN	\$17.68
874-128	128 mm (5-1/16") CC	7-5/8"	10	ABSB, BNBDL, DBAC, SN	\$24.15
874-160	160 mm (6-5/16") CC	9-1/8"	10	ABSB, BNBDL, DBAC, SN	\$30.15





Bremen 1 - Contemporary Finishes

New finish

Item	Description	Overall Length or Diameter	Ctn Qty	Finishes	List (each)
117	knob	1-1/4"	20	BNBDL, DBAC, NI, PC, SBZ, SN	\$5.55
527	96 mm (3-3/4") CC	4-5/8"	15	BNBDL, DBAC, NI, PC, SBZ, SN	\$11.11
527-128	128 mm (5-1/16") CC	5-7/8"	10	BNBDL, DBAC, NI, PC, SBZ, SN	\$12.92
527-160	160 mm (6-5/16") CC	7-1/8"	10	BNBDL, DBAC, NI, PC, SBZ, SN	\$16.60
527-12	12" CC appliance pull	13-1/16"	5	BNBDL, DBAC, NI, PC, SBZ, SN	\$131.00



BNBDL
Brushed Pewter



DBAC
Brushed Oil
Rubbed Bronze



NI
Polished
Nickel



PC
Polished
Chrome



SN
Satin Bronze
NEW



SN
Satin Nickel

*Switching from
3" CC to 96 mm?*
Use Pull Escutcheons
to cover the old holes
See PE07 on page 148



Bremen 1 - Traditional Finishes

Item	Description	Overall Length or Diameter	Ctn Qty	Finishes	List (each)
117	knob	1-1/4"	20	ABM-D, ABSB, DACM, DMAC, SIM	\$5.55
527	96 mm (3-3/4") CC	4-5/8"	15	ABM-D, ABSB, DACM, DMAC, SIM	\$11.11
527-128	128 mm (5-1/16") CC	5-7/8"	10	ABM-D, ABSB, DACM, DMAC, SIM	\$12.92
527-160	160 mm (6-5/16") CC	7-1/8"	10	ABM-D, ABSB, DACM, DMAC, SIM	\$16.60
527-12	12" CC appliance pull	13-1/16"	5	ABM-D, ABSB, DACM, DMAC, SIM	\$131.00



**Switching from
3" CC to 96 mm?**
Use Pull Escutcheons
to cover the old holes
See PE07 on page 148

JEFFREY ALEXANDER®

by Hardware Resources



Bremen 2

Item	Description	Overall Length or Diameter	Ctn Qty	Finishes	List (each)
127	knob (barrel)	1-3/16"	20	ABSB, DACM, DBAC, DMAC, NI, SN	\$5.55
137	knob (stacked)	1-1/4"	30	ABSB, DACM, DBAC, DMAC, NI, SN	\$7.40
537	96 mm (3-3/4") CC	4-3/16"	20	ABSB, DACM, DBAC, DMAC, NI, SN	\$9.25
537-128	128 mm (5-1/16") CC	5-7/16"	10	ABSB, DACM, DBAC, DMAC, NI, SN	\$11.11
537-160	160 mm (6-5/16") CC	6-9/16"	10	ABSB, DACM, DBAC, DMAC, NI, SN	\$12.92
537-12	12" CC appliance pull	12-11/16"	5	ABSB, DACM, DBAC, DMAC, NI, SN	\$131.00



*Switching from
3" CC to 96 mm?*
Use Pull Escutcheons
to cover the old holes
See PE07 on page 148



Cairo

Item	Description	Overall Length or Diameter	Ctn Qty	Finishes	List (each)
595	knob	1-1/4"	20	BNBDL, DBAC, PC, SN	\$5.59
595-96	96 mm (3-3/4") CC	4-13/16"	20	BNBDL, DBAC, PC, SN	\$7.60
595-128	128 mm (5-1/16") CC	6-1/16"	15	BNBDL, DBAC, PC, SN	\$9.15



JEFFREY ALEXANDER®

by Hardware Resources



Callie

US Patent # 790,315

Item	Description	Overall Length or Diameter	Ctn Qty	Finishes	List (each)
839-3	3" CC	4-3/16"	20	BNBDL, DBAC, NI, PC, SN	\$8.85
839-96	96 mm (3-3/4") CC	4-15/16"	15	BNBDL, DBAC, NI, PC, SN	\$11.38
839-128	128 mm (5-1/16") CC	6-1/4"	15	BNBDL, DBAC, NI, PC, SN	\$13.68
839-160	160 mm (6-5/16") CC	7-1/2"	10	BNBDL, DBAC, NI, PC, SN	\$16.38



JEFFREY ALEXANDER®

by Hardware Resources



Chesapeake

Item	Description	Overall Length or Diameter	Ctn Qty	Finishes	List (each)
915	knob (back right)	1-5/16"	50	ABSB, BNBDL, DACM, DBAC, SIM, SN	\$6.45
Z110	knob (front)	1-3/16"	30	ABSB, BNBDL, BNLD, DACM, DBAC, SIM, SN	\$4.05
737-96	96 mm (3-3/4") CC	4-1/4"	20	ABSB, BNBDL, DACM, DBAC, SIM, SN	\$8.78
737-128	128 mm (5-1/16") CC	5-1/2"	15	ABSB, BNBDL, DACM, DBAC, SIM, SN	\$10.99
737-160	160 mm (6-5/16") CC	6-3/4"	10	ABSB, BNBDL, DACM, DBAC, SIM, SN	\$13.35
737-12	12" CC appliance pull	12-15/16"	5	ABSB, BNBDL, DACM, DBAC, SIM, SN	\$131.00



ABSB
Antique Brushed
Satin Brass



BNBDL
Brushed
Pewter



DACM
Gun Metal



DBAC
Brushed Oil
Rubbed Bronze



SIM
Distressed
Antique Silver



SN
Satin Nickel

*Switching from
3" CC to 96 mm?*
Use Pull Escutcheons
to cover the old holes
See PE07 on page 148

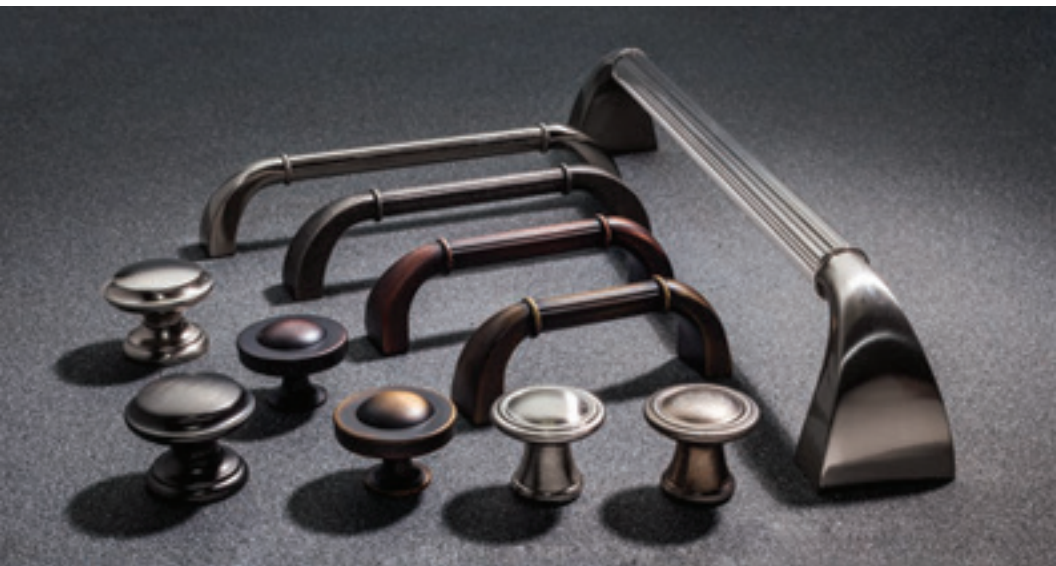

Cordova

Item	Description	Overall Length or Diameter	Ctn Qty	Finishes	List (each)
0251	knob (left)	1-3/8"	25	ABSB, BNBDL, DBAC, SN	\$5.39
Z110	knob (right)	1-3/16"	30	ABSB, BNBDL, BNDL, DACM, DBAC, SIM, SN	\$4.05
Z111	knob (center)	1-1/4"	30	ABSB, BNDL, DBAC, SN	\$5.25
Z281	3" CC	3-3/8"	20	ABSB, BNDL, DBAC, SN	\$7.30
Z280	96 mm (3-3/4") CC	4-3/16"	20	ABSB, BNDL, DBAC, SN	\$8.89
Z281-128	128 mm (5-1/16") CC	5-7/16"	10	ABSB, BNDL, DBAC, SN	\$12.75
Z281-160	160 mm (6-5/16") CC	6-11/16"	10	ABSB, BNDL, DBAC, SN	\$16.38
Z281-12	12" CC appliance pull	12-3/4"	5	ABSB, BNDL, DBAC, SN	\$131.00
Z281-18	18" CC appliance pull	18-3/4"	5	ABSB, BNDL, DBAC, SN	\$165.00



JEFFREY ALEXANDER®

by Hardware Resources



Delgado

US Patent # D612,703; D598,269

Item	Description	Overall Length or Diameter	Ctn Qty	Finishes	List (each)
519	knob	1-9/16"	30	ABSB, BNBDL, DBAC, NI, SN	\$10.25
519-96	96 mm (3-3/4") CC	4-1/4"	10	ABSB, BNBDL, DBAC, NI, SN	\$18.35
519-128	128 mm (5-1/16") CC	5-9/16"	10	ABSB, BNBDL, DBAC, NI, SN	\$30.55
519-160	160 mm (6-5/16") CC	6-13/16"	10	ABSB, BNBDL, DBAC, NI, SN	\$38.59
519-12	12" CC appliance pull	12-1/2"	5	ABSB, BNBDL, DBAC, NI, SN	\$141.00
519-18	18" CC appliance pull	18-1/2"	5	ABSB, BNBDL, DBAC, NI, SN	\$174.00



JEFFREY ALEXANDER®

by Hardware Resources

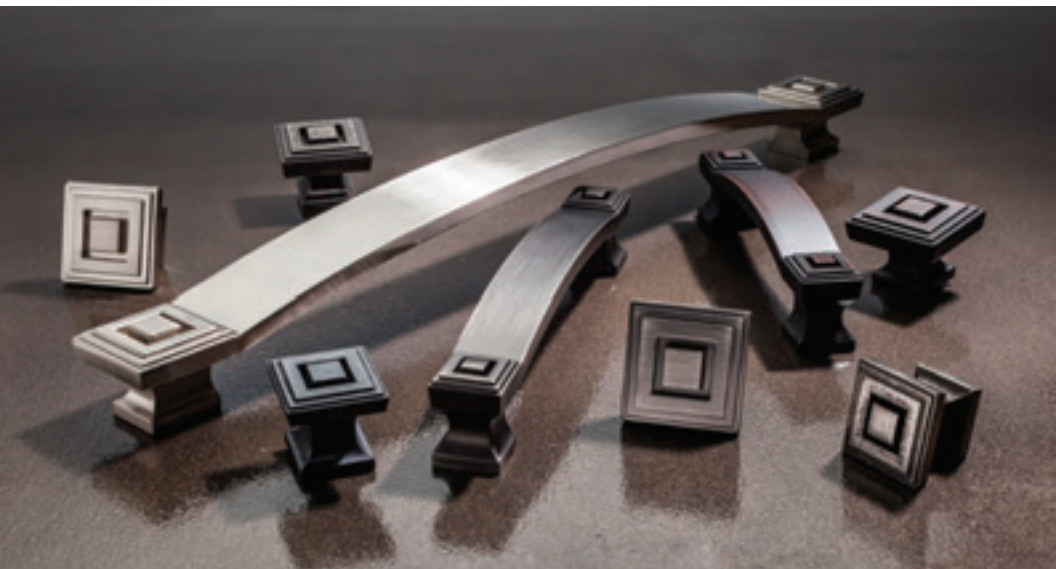

Delmar

US Patent # D680,409; D680,414; D680,408

Item	Description	Overall Length or Diameter	Ctn Qty	Finishes	List (each)
585	small knob	1"	20	BNBDL, DACM, DBAC, DP, SN	\$10.41
585L	large knob	1-1/4"	20	BNBDL, DACM, DBAC, DP, SN	\$12.99
585-96	96 mm (3-3/4") CC	4-1/2"	10	BNBDL, DACM, DBAC, DP, SN	\$16.45
585-128	128 mm (5-1/16") CC	5-13/16"	10	BNBDL, DACM, DBAC, DP, SN	\$26.19
585-160	160 mm (6-5/16") CC	7-1/16"	10	BNBDL, DACM, DBAC, DP, SN	\$33.75
585-12	12" CC appliance pull	13-1/4"	5	BNBDL, DACM, DBAC, DP, SN	\$156.00



BNBDL
Brushed Pewter

DACM
Gun Metal

DBAC
Brushed Oil
Rubbed Bronze

DP
Distressed
Pewter

SN
Satin Nickel



Durham

Item	Description	Overall Length or Diameter	Ctn Qty	Finishes	List (each)
3980	knob	1-1/4"	20	ABSB, BNBDL, DACM, DBAC, ORB, PC, SN	\$6.87
Z290-3	3" CC	3-3/8"	25	ABSB, BNBDL, DACM, DBAC, ORB, PC, SN	\$5.45
Z290-96	96 mm (3-3/4") CC	4-1/4"	20	ABSB, BNBDL, DACM, DBAC, ORB, PC, SN	\$6.85
Z290-128	128 mm (5-1/16") CC	5-1/2"	15	ABSB, BNBDL, DACM, DBAC, ORB, PC, SN	\$14.55
Z290-160	160 mm (6-5/16") CC	6-3/4"	10	ABSB, BNBDL, DACM, DBAC, ORB, PC, SN	\$16.60
Z290-12	12" CC appliance pull	13"	5	ABSB, BNBDL, DACM, DBAC, ORB, PC, SN	\$131.00



Switching from 3" CC to 96 mm?
Use Pull Escutcheons to cover the old holes
See PE07 on page 148

JEFFREY ALEXANDER®

by Hardware Resources



Duval

US Patent # D661,974; D661,965

Item	Description	Overall Length or Diameter	Ctn Qty	Finishes	List (each)
343	knob	1-1/4"	20	BNBDL, DACM, DBAC, NI, SN	\$12.10
343-96	96 mm (3-3/4") CC	4-1/2"	10	BNBDL, DACM, DBAC, NI, SN	\$16.71
343-128	128 mm (5-1/16") CC	5-13/16"	10	BNBDL, DACM, DBAC, NI, SN	\$22.79
343-160	160 mm (6-5/16") CC	7-1/16"	10	BNBDL, DACM, DBAC, NI, SN	\$25.30
343-12	12" CC appliance pull	13-1/8"	5	BNBDL, DACM, DBAC, NI, SN	\$165.00



BNBDL
Brushed Pewter



DACM
Gun Metal



DBAC
Brushed Oil
Rubbed Bronze



NI
Polished Nickel



SN
Satin Nickel



Elara

New Collection

Coming early 2019

Item	Description	Overall Length or Diameter	Ctn Qty	Finishes	List (each)
484	knob	1-1/4"	20	BNBDL, DBAC, MB, PC, SBZ, SN	\$5.85
484-32	32 mm (1-1/4") CC	2-1/16"	10	BNBDL, DBAC, MB, PC, SBZ, SN	\$7.25
484-396	3" CC, 96 mm (3-3/4") CC	4-9/16"	10	BNBDL, DBAC, MB, PC, SBZ, SN	\$11.75
484-128160	128 mm (5") CC, 160 mm (6-1/4") CC	7-1/8"	10	BNBDL, DBAC, MB, PC, SBZ, SN	\$16.25
484-192224	192 mm (7-9/16") CC, 224 mm (8 13/16") CC	9-5/8"	5	BNBDL, DBAC, MB, PC, SBZ, SN	\$22.75
484-305	305 mm (12") CC	12-13/16"	5	BNBDL, DBAC, MB, PC, SBZ, SN	\$57.99

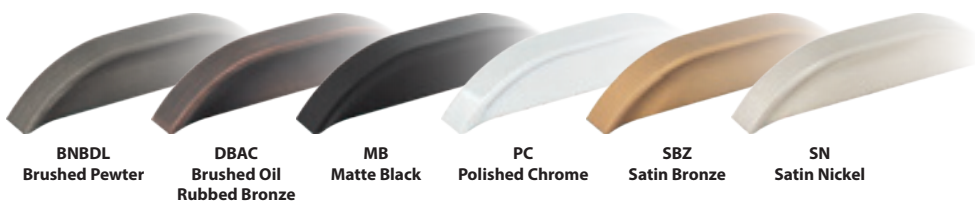

BNBDL
Brushed Pewter

DBAC
Brushed Oil
Rubbed Bronze

MB
Matte Black

PC
Polished Chrome

SBZ
Satin Bronze

SN
Satin Nickel

JEFFREY ALEXANDER®

by Hardware Resources



Ella

US Patent # D737,112; D728,343

Item	Description	Overall Length or Diameter	Ctn Qty	Finishes	List (each)
165	knob	1-1/4"	20	BNBDL, DBAC, NI, PC, SN	\$8.68
165-96	96 mm (3-3/4") CC	4-1/2"	10	BNBDL, DBAC, NI, PC, SN	\$14.91
165-128	128 mm (5-1/16") CC	5-13/16"	10	BNBDL, DBAC, NI, PC, SN	\$18.35
165-160	160 mm (6-5/16") CC	7-1/16"	10	BNBDL, DBAC, NI, PC, SN	\$22.15
165-12	12" CC appliance pull	13"	5	BNBDL, DBAC, NI, PC, SN	\$141.00





Encada

US Patent # D602,337; D602,333; D609,074; D602,332

Item	Description	Overall Length or Diameter	Ctn Qty	Finishes	List (each)
123 (wave)	knob	1-3/16"	20	AEM, BNBDL, DBAC, SN	\$12.25
123-96 (wave)	96 mm (3-3/4") CC	4-13/16"	20	AEM, BNBDL, DBAC, SN	\$13.23
125 (rope)	knob	1-3/16"	25	AEM, BNBDL, DBAC, SN	\$12.25
125-96 (rope)	96 mm (3-3/4") CC	4-13/16"	20	AEM, BNBDL, DBAC, SN	\$13.23



AEM
Lightly Distressed
Antique Brass

BNBDL
Brushed Pewter

DBAC
Brushed Oil
Rubbed Bronze

SN
Satin Nickel

*Switching from
3" CC to 96 mm?*
Use Pull Escutcheons
to cover the old holes
See PE07 on page 148

JEFFREY ALEXANDER®

by Hardware Resources



Evangeline

US Patent # D646,551; D646,550

Item	Description	Overall Length or Diameter	Ctn Qty	Finishes	List (each)
925	knob	1-3/4"	30	ABSB, BNBDL, DBAC, SN	\$9.75
925-96	96 mm (3-3/4") CC	6-1/2"	20	ABSB, BNBDL, DBAC, SN	\$13.79



ABSB
Antique Brushed
Satin Brass



BNBDL
Brushed Pewter



DBAC
Brushed Oil
Rubbed Bronze



SN
Satin Nickel



Glenmore

Item	Description	Overall Length or Diameter	Ctn Qty	Finishes	List (each)
618	small knob	2-5/8"	25	ABSB, BNMDL, DACM, DBAC	\$6.45
618L	large knob	2-15/16"	15	ABSB, BNMDL, DACM, DBAC	\$10.99
718	128 mm (5-1/16") CC	5-3/4"	25	ABSB, BNMDL, DACM, DBAC	\$12.75
718-128	128 mm (5-1/16") CC bail pull	5-15/16"	10	ABSB, BNMDL, DACM, DBAC	\$16.38
Z718-12	12" CC appliance pull	13-5/16"	5	ABSB, BNMDL, DACM, DBAC	\$131.00





Harlow

Item	Description	Overall Length or Diameter	Ctn Qty	Base Finishes	List
G110	small egg	1-1/4"	10	BNBDL, DBAC, PC, SN	\$16.50
G110L	large egg	1-5/8"	10	BNBDL, DBAC, PC, SN	\$25.75
G120	small button	1-7/16"	10	BNBDL, DBAC, PC, SN	\$16.50
G120L	large button	1-3/4"	10	BNBDL, DBAC, PC, SN	\$25.75
G130	small sphere	1-1/16"	10	BNBDL, DBAC, PC, SN	\$14.15
G130L	large sphere	1-3/8"	10	BNBDL, DBAC, PC, SN	\$17.65
G140	small square	1"	10	BNBDL, DBAC, PC, SN	\$16.50
G140L	large square	1-3/8"	10	BNBDL, DBAC, PC, SN	\$25.75
G150	small faceted	1"	10	BNBDL, DBAC, PC, SN	\$14.15
G150L	large faceted	1-1/4"	10	BNBDL, DBAC, PC, SN	\$17.65



BNBDL
Brushed Pewter



DBAC
Brushed Oil
Rubbed Bronze



PC
Polished
Chrome



SN
Satin Nickel

JEFFREY ALEXANDER®

by Hardware Resources



Hayworth

US Patent # D787,297; D787,296

Item	Description	Overall Length or Diameter	Ctn Qty	Finishes	List (each)
885	knob	1-1/8"	25	NI, PC, SN	\$7.99
885L	T knob	2"	25	NI, PC, SN	\$9.45
885-96	96 mm (3-3/4") CC	4-3/4"	10	NI, PC, SN	\$14.35
885-128	128 mm (5-1/16") CC	6"	10	NI, PC, SN	\$16.65
885-160	160 mm (6-5/16") CC	7-1/4"	10	NI, PC, SN	\$19.35
885-192	192 mm (7-9/16") CC	8-1/2"	10	NI, PC, SN	\$22.35
885-224	224 mm (8-13/16") CC	9-3/4"	10	NI, PC, SN	\$25.30
885-305	12" CC appliance pull	12-15/16"	10	NI, PC, SN	\$60.25



NI
Polished Nickel



PC
Polished Chrome



SN
Satin Nickel



Hudson

Item	Description	Overall Length or Diameter	Ctn Qty	Finishes	List (each)
650	knob	1-7/8"	25	BNBDL, DBAC, PC, SN	\$7.25
650-96	96 mm (3-3/4") CC	4-3/8"	30	BNBDL, DBAC, PC, SN	\$9.05
650-128	128 mm (5-1/16") CC	5-5/8"	25	BNBDL, DBAC, PC, SN	\$10.99
650-160	160 mm (6-5/16") CC	6-15/16"	10	BNBDL, DBAC, PC, SN	\$14.35
650-12	12" CC appliance pull	13"	5	BNBDL, DBAC, PC, SN	\$131.00



**Switching from
3" CC to 96 mm?**
Use Pull Escutcheons
to cover the old holes
See PE07 on page 148

JEFFREY ALEXANDER®

by Hardware Resources



Katharine

US Patent # D728,341; D729,037

Item	Description	Overall Length or Diameter	Ctn Qty	Finishes	List (each)
188	small knob	7/8"	20	BNBDL, DBAC, PC, SN	\$9.25
188L	large knob	1"	15	BNBDL, DBAC, PC, SN	\$10.25
188-96	96 mm (3-3/4") CC	4-3/8"	15	BNBDL, DBAC, PC, SN	\$14.20
188-128	128 mm (5-1/16") CC	5-11/16"	15	BNBDL, DBAC, PC, SN	\$18.85
188-160	160 mm (6-5/16") CC	6-15/16"	10	BNBDL, DBAC, PC, SN	\$23.15



BNBDL
Brushed Pewter



DBAC
Brushed Oil
Rubbed Bronze



PC
Polished
Chrome



SN
Satin Nickel

**Switching from
3" CC to 96 mm?**
Use Pull Escutcheons
to cover the old holes
See PE07 on page 148



Key Grande

New finish

Item	Description	Overall Length or Diameter	Ctn Qty	Finishes	List (each)
596	96 mm (3-3/4") CC	5-3/8"	20	BG, SN	\$16.38
5128	128 mm (5-1/16") CC	6-5/8"	20	BG, SN	\$18.25
5192	192 mm (7-9/16") CC	9-1/8"	10	BG, SN	\$22.05
5224	224 mm (8-13/16") CC	10-3/8"	10	BG, SN	\$23.50
5319	319 mm (12-9/16") CC	14-1/8"	10	BG, SN	\$29.09
5480	480 mm (18-7/8") CC	20-1/2"	10	SN	\$34.39
5673	673 mm (26-1/2") CC	28-1/16"	10	SN	\$45.75
5900	900 mm (35-7/16") CC	37"	5	SN	\$60.25



BG
Brushed Gold
NEW



SN
Satin Nickel

Switching from 3" CC to 96 mm?
Use Pull Escutcheons to cover the old holes
See PE07 on page 148



Key West & Key Largo

New finishes

Item	Description	Overall Length or Diameter	Ctn Qty	Finishes	List (each)
48	T knob	1-7/8"	30	BG, MB, ORB, SBZ, SN	\$5.59
146	96 mm (3-3/4") CC	5-3/4"	10	BG, MB, ORB, SBZ, SN	\$11.25
152	96 mm (3-3/4") CC	6"	10	BG, MB, ORB, SBZ, SN	\$11.85
178	128 mm (5-1/16") CC	7"	10	BG, MB, ORB, SBZ, SN	\$13.15
242	192 mm (7-9/16") CC	9-1/2"	10	BG, MB, ORB, SBZ, SN	\$14.97
274	224 mm (8-13/16") CC	10-3/4"	10	BG, MB, ORB, SBZ, SN	\$16.25
370	319 mm (12-9/16") CC	14-9/16"	10	BG, MB, ORB, SBZ, SN	\$18.50
530	480 mm (18-7/8") CC	20-7/8"	10	SN	\$25.05
722	673 mm (26-1/2") CC	28-7/16"	10	SN	\$40.25
950	900 mm (35-7/16") CC	37-3/8"	10	SN	\$47.00



Switching from 3" CC to 96 mm?
Use Pull Escutcheons to cover the old holes
See PE07 on page 148



JEFFREY ALEXANDER®

by Hardware Resources



Kensington

US Patent # D602,338; D602,335

Item	Description	Overall Length or Diameter	Ctn Qty	Finishes	List (each)
531 [†]	knob	1-3/8"	25	ABSB, BNBDL, DBAC, SN	\$12.78
531-96 [†]	96 mm (3-3/4") CC	5-3/4"	20	ABSB, BNBDL, DBAC, SN	\$13.53



JEFFREY ALEXANDER®

by Hardware Resources



Lafayette

US Patent # D605,924; D602,334; D637,059

Item	Description	Overall Length or Diameter	Ctn Qty	Finishes	List (each)
218	fleur-de-lis knob	1-3/8"	30	ABSB, BNBDL, DBAC, SN	\$11.81
317	circles knob	1-3/8"	20	ABSB, BNBDL, DBAC, SN	\$10.71
417	Baroque (pattern) knob	1-3/8"	30	ABSB, BNBDL, DBAC, SN	\$11.25
317-96	96 mm (3-3/4") CC	4-3/8"	20	ABSB, BNBDL, DBAC, SN	\$15.55
317-128	128 mm (5-1/16") CC	5-5/8"	20	ABSB, BNBDL, DBAC, SN	\$17.25
317-160	160 mm (6-5/16") CC	6-7/8"	15	ABSB, BNBDL, DBAC, SN	\$20.35
317-12	12" CC appliance pull	12-15/16"	5	ABSB, BNBDL, DBAC, SN	\$152.00



**Switching from
3" CC to 96 mm?**
Use Pull Escutcheons
to cover the old holes
See PE07 on page 148



Lenoir

Item	Description	Overall Length or Diameter	Ctn Qty	Finishes	List (each)
Z117	knob	1-1/4"	25	ABSB, BNBDL, DACM, DBAC, MB, ORB, SIM, SN	\$5.45
8237	96 mm (3-3/4") CC	5"	25	ABSB, BNBDL, DACM, DBAC, MB, ORB, SIM, SN	\$6.45



ABSB
Antique Brushed
Satin Brass



BNBDL
Brushed Pewter



DACM
Gun Metal



DBAC
Brushed Oil
Rubbed Bronze



MB
Matte Black



ORB
Dark Bronze



SIM
Distressed
Antique Silver



SN
Satin Nickel

JEFFREY ALEXANDER®

by Hardware Resources



Lexa

US Patent # D718,111; D719,008

Item	Description	Overall Length or Diameter	Ctn Qty	Finishes	List (each)
259	knob	2"	30	BN, BNBDL, DBAC, PC, SN	\$9.65
259-96	96 mm (3-3/4") CC	4-3/16"	15	BN, BNBDL, DBAC, PC, SN	\$16.45
259-128	128 mm (5-1/16") CC	5-7/16"	10	BN, BNBDL, DBAC, PC, SN	\$19.55
259-160	160 mm (6-5/16") CC	6-11/16"	10	BN, BNBDL, DBAC, PC, SN	\$21.85
259-192	192 mm (7-9/16") CC	8"	10	BN, BNBDL, DBAC, PC, SN	\$25.75

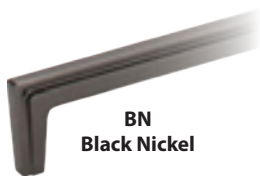

BN
Black Nickel



BNBDL
Brushed Pewter



DBAC
Brushed Oil
Rubbed Bronze



PC
Polished Chrome



SN
Satin Nickel



Leyton

New finish

Item	Description	Overall Length or Diameter	Ctn Qty	Finishes	List (each)
286-96	96 mm (3-3/4") CC	5-1/8"	10	BNBDL, DBAC, NI, PC, SBZ, SN	\$12.85
286-128	128 mm (5-1/16") CC	6-3/8"	10	BNBDL, DBAC, NI, PC, SBZ, SN	\$14.50
286-160	160 mm (6-5/16") CC	7-11/16"	10	BNBDL, DBAC, NI, PC, SBZ, SN	\$17.20
286-192	192 mm (7-9/16") CC	8-15/16"	10	BNBDL, DBAC, NI, PC, SBZ, SN	\$20.20
286-224	224 mm (8-13/16") CC	10-3/16"	10	BNBDL, DBAC, NI, PC, SBZ, SN	\$23.15



BNBDL
Brushed Pewter



DBAC
Brushed Oil
Rubbed Bronze



NI
Polished Nickel



PC
Polished Chrome



SBZ
Satin Bronze
NEW



SN
Satin Nickel

JEFFREY ALEXANDER®

by Hardware Resources



Lille

US Patent # D568,139; D568,140; D568,141

Item	Description	Overall Length or Diameter	Ctn Qty	Finishes	List (each)
415S	small knob	1-1/4"	30	ABSB, BNBDL, DACM, DBAC, SN	\$9.15
415	large knob	1-3/8"	30	ABSB, BNBDL, DACM, DBAC, SN	\$12.49
415-96	96 mm (3-3/4") CC	4-3/8"	20	ABSB, BNBDL, DACM, DBAC, SN	\$10.95
415-96V	96 mm (3-3/4") CC asymmetrical	4-3/4"	20	ABSB, BNBDL, DACM, DBAC, SN	\$15.35
415-128	128 mm (5-1/16") CC	5-5/8"	20	ABSB, BNBDL, DACM, DBAC, SN	\$18.29
415-160	160 mm (6-5/16") CC	6-7/8"	15	ABSB, BNBDL, DACM, DBAC, SN	\$23.59
415-12	12" CC appliance pull	12-7/8"	5	ABSB, BNBDL, DACM, DBAC, SN	\$131.00



**Switching from
3" CC to 96 mm?**
Use Pull Escutcheons
to cover the old holes
See PE07 on page 148

JEFFREY ALEXANDER®

by Hardware Resources



Lyon

New finishes

Item	Description	Overall Length or Diameter	Ctn Qty	Finishes	List (each)
3991	egg knob	1-9/16"	25	AB, BG, BLK, BNBDL, DACM, DBAC, NI, ORB, PC, SIM, SBZ, SN	\$8.59
8233	3" CC	4-15/16"	25	AB, BG, BLK, BNBDL, DACM, DBAC, NI, ORB, PC, SIM, SBZ, SN	\$7.25



AB
Brushed
Antique
Brass

BG
Brushed
Gold
NEW

BLK
Matte
Black

BNBDL
Brushed
Pewter

DACM
Gun
Metal

DBAC
Brushed Oil
Rubbed Bronze



NI
Polished
Nickel

ORB
Dark
Bronze

PC
Polished
Chrome

SIM
Distressed
Antique
Silver

SBZ
Satin
Bronze
NEW

SN
Satin
Nickel

JEFFREY ALEXANDER®

by Hardware Resources



Marlo

US Patent # D786,648; D790,316

Item	Description	Overall Length or Diameter	Ctn Qty	Finishes	List (each)
972S	small knob	7/8"	30	BNBDL, DBAC, NI, PC, SN	\$6.85
972	medium knob	1-1/8"	20	BNBDL, DBAC, NI, PC, SN	\$8.35
972L	large knob	1-1/4"	20	BNBDL, DBAC, NI, PC, SN	\$10.25
972-96	96 mm (3-3/4") CC	4-1/2"	10	BNBDL, DBAC, NI, PC, SN	\$14.50
972-128	128 mm (5-1/16") CC	5-13/16"	10	BNBDL, DBAC, NI, PC, SN	\$18.10
972-160	160 mm (6-5/16") CC	7-1/16"	10	BNBDL, DBAC, NI, PC, SN	\$21.85
972-224	224 mm (8-13/16") CC	9-3/4"	15	BNBDL, DBAC, NI, PC, SN	\$25.40
972-305	305 mm (12") CC	12-3/4"	10	BNBDL, DBAC, NI, PC, SN	\$60.25
972-12	12" CC appliance pull	13"	5	BNBDL, DBAC, NI, PC, SN	\$141.00



BNBDL
Brushed
Pewter

DBAC
Brushed Oil
Rubbed Bronze

NI
Polished
Nickel

PC
Polished
Chrome

SN
Satin Nickel

JEFFREY ALEXANDER®

by Hardware Resources



Maybeck

US Patent # D724,411; D724,410

Item	Description	Overall Length or Diameter	Ctn Qty	Finishes	List (each)
225	knob	1-11/16"	20	BN, BNBDL, DBAC, PC, SN	\$10.11
225-96	96 mm (3-3/4") CC	5-1/4"	15	BN, BNBDL, DBAC, PC, SN	\$20.58
225-128	128 mm (5-1/16") CC	6-3/8"	15	BN, BNBDL, DBAC, PC, SN	\$23.75
225-160	160 mm (6-5/16") CC	7-7/16"	10	BN, BNBDL, DBAC, PC, SN	\$27.59





Merrick

New finishes

Item	Description	Overall Length or Diameter	Ctn Qty	Finishes	List (each)
549-96	96 mm (3-3/4") CC	4-3/16"	25	BNBDL, DBAC, MB, PC, SBZ, SN	\$7.99
549-128	128 mm (5-1/16") CC	5-1/2"	15	BNBDL, DBAC, MB, PC, SBZ, SN	\$9.15
549-160	160 mm (6-5/16") CC	6-3/4"	15	BNBDL, DBAC, MB, PC, SBZ, SN	\$10.38
549-192	192 mm (7-9/16") CC	8"	20	BNBDL, DBAC, MB, PC, SBZ, SN	\$11.71
549-320	320 mm (12-5/8") CC	13-1/16"	10	BNBDL, DBAC, MB, PC, SBZ, SN	\$30.75



BNBDL
Brushed Pewter



DBAC
Brushed Oil
Rubbed Bronze



MB
Matte Black
NEW



PC
Polished Chrome



SBZ
Satin Bronze
NEW



SN
Satin Nickel

JEFFREY ALEXANDER®

by Hardware Resources



Milan 1

Item	Description	Overall Length or Diameter	Ctn Qty	Finishes	List (each)
1091	knob	1-3/16"	20	AB, AEM, BNBDL, DACM, DBAC, PC, SN	\$9.05
1092	96 mm (3-3/4") CC	4-1/4"	20	AB, AEM, BNBDL, DACM, DBAC, PC, SN	\$10.18
1092-128	128 mm (5-1/16") CC	5-9/16"	25	AB, AEM, BNBDL, DACM, DBAC, PC, SN	\$13.89
1092-160	160 mm (6-5/16") CC	6-13/16"	20	AB, AEM, BNBDL, DACM, DBAC, PC, SN	\$16.60
1092-12	12" CC appliance pull	12-13/16"	5	AB, AEM, BNBDL, DACM, DBAC, PC, SN	\$131.00



AB
Brushed
Antique Brass



AEM
Lightly Distressed
Antique Brass



BNBDL
Brushed Pewter



DACM
Gun Metal



DBAC
Brushed Oil
Rubbed Bronze



PC
Polished Chrome



SN
Satin Nickel

**Switching from
3" CC to 96 mm?**
Use Pull Escutcheons
to cover the old holes
See PE07 on page 148



Milan 2

Item	Description	Overall Length or Diameter	Ctn Qty	Finishes	List (each)
1093	knob	1-3/16"	20	AB, AEM, BNBDL, DACM, DBAC, SN	\$10.18
1094	96 mm (3-3/4") CC	4-1/4"	20	AB, AEM, BNBDL, DACM, DBAC, SN	\$12.68
1094-128	128 mm (5-1/16") CC	5-9/16"	25	AB, AEM, BNBDL, DACM, DBAC, SN	\$16.48
1094-160	160 mm (6-5/16") CC	6-13/16"	20	AB, AEM, BNBDL, DACM, DBAC, SN	\$17.60
1094-12	12" CC appliance pull	12-13/16"	5	AB, AEM, BNBDL, DACM, DBAC, SN	\$131.00



AB
Brushed
Antique Brass



AEM
Lightly Distressed
Antique Brass



BNBDL
Brushed Pewter



DACM
Gun Metal



DBAC
Brushed Oil
Rubbed Bronze



SN
Satin Nickel

**Switching from
3" CC to 96 mm?**

Use Pull Escutcheons
to cover the old holes
See PE07 on page 148

JEFFREY ALEXANDER®

by Hardware Resources

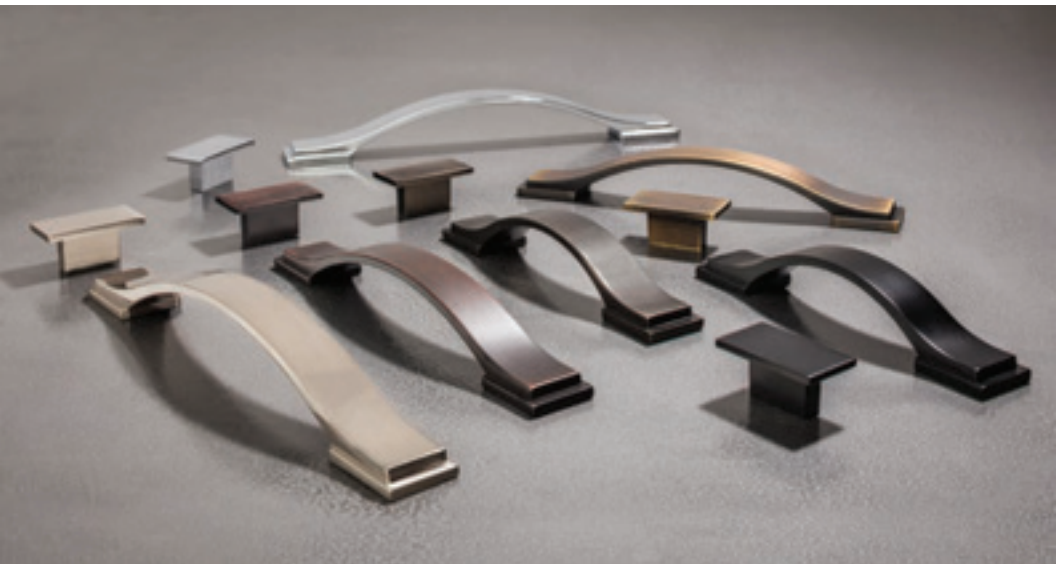

Mirada

New finish

Item	Description	Overall Length or Diameter	Ctn Qty	Finishes	List (each)
81021	16 mm (5/8") CC knob	1-9/16"	30	ABSB, BNBDL, DBAC, MB, PC, SN	\$5.45
80152-96	96 mm (3-3/4") CC	5-9/16"	20	ABSB, BNBDL, DBAC, MB, PC, SN	\$14.85
80152-128	128 mm (5-1/16") CC	6-13/16"	20	ABSB, BNBDL, DBAC, MB, PC, SN	\$16.77
80152-160	160 mm (6-5/16") CC	8-1/16"	15	ABSB, BNBDL, DBAC, MB, PC, SN	\$18.85



JEFFREY ALEXANDER®

by Hardware Resources



Modena

US Patent # D570,185; D580,733

Item	Description	Overall Length or Diameter	Ctn Qty	Finishes	List (each)
910S	small knob	1"	30	PC, SBN, SN	\$8.09
910	large knob	1-3/16"	30	PC, SBN, SN	\$10.11
910-96	96 mm (3-3/4") CC	4-1/4"	25	PC, SBN, SN	\$14.01
910-128	128 mm (5-1/16") CC	5-9/16"	15	PC, SBN, SN	\$18.35
910-160	160 mm (6-5/16") CC	6-13/16"	25	PC, SBN, SN	\$20.35
910-12	12" CC appliance pull	12-13/16"	5	PC, SBN, SN	\$141.00



*Switching from
3" CC to 96 mm?*
Use Pull Escutcheons
to cover the old holes
See PE07 on page 148

JEFFREY ALEXANDER®

by Hardware Resources



Montclair

US Patent # D661,967; D661,973

Item	Description	Overall Length or Diameter	Ctn Qty	Finishes	List (each)
935	knob	2"	20	ABSB, BNBDL, DBAC, SN	\$14.05
935-96	96 mm (3-3/4") CC	5-5/8"	10	ABSB, BNBDL, DBAC, SN	\$19.55
935-128	128 mm (5-1/16") CC	7-1/2"	10	ABSB, BNBDL, DBAC, SN	\$24.75
935-160	160 mm (6-5/16") CC	8-3/4"	10	ABSB, BNBDL, DBAC, SN	\$27.07
935-12	12" CC appliance pull	16"	5	ABSB, BNBDL, DBAC, SN	\$174.00



JEFFREY ALEXANDER®

by Hardware Resources



Odessa

US Patent # D633,364; D634,179

Item	Description	Overall Length or Diameter	Ctn Qty	Finishes	List (each)
112 [†]	knob	1-3/4"	30	ABSB, BNBDL, DBAC, SN	\$13.31
112-96 [†]	96 mm (3-3/4") CC	5-3/4"	15	ABSB, BNBDL, DBAC, SN	\$17.05



These products are being retired.
Call for availability on products marked with "†".

JEFFREY ALEXANDER®

by Hardware Resources



Padua

US Patent # D639,134; D634,176

Item	Description	Overall Length or Diameter	Ctn Qty	Finishes	List (each)
211 [†]	knob	1-9/16"	30	ABSB, BNBDL, DBAC, SN	\$11.95
212-96 [†]	96 mm (3-3/4") CC	5-3/8"	20	ABSB, BNBDL, DBAC, SN	\$13.59



ABSB
Antique Brushed
Satin Brass



BNBDL
Brushed Pewter



DBAC
Brushed Oil
Rubbed Bronze



SN
Satin Nickel

**Switching from
3" CC to 96 mm?**
Use Pull Escutcheons
to cover the old holes
See PE07 on page 148



JEFFREY ALEXANDER®

by Hardware Resources



Prestige

US Patent # D661,970; D661,966; D660,680

Item	Description	Overall Length or Diameter	Ctn Qty	Finishes	List (each)
918	round knob	1-3/8"	20	AEM, BNBDL, DP, NI, SN	\$14.65
918L	T knob	2-1/4"	20	AEM, BNBDL, DP, NI, SN	\$18.35
918-96	96 mm (3-3/4") CC	4-3/8"	15	AEM, BNBDL, DP, NI, SN	\$21.10
918-128	128 mm (5-1/16") CC	5-11/16"	15	AEM, BNBDL, DP, NI, SN	\$25.40
918-160	160 mm (6-5/16") CC	6-15/16"	10	AEM, BNBDL, DP, NI, SN	\$31.15
918-12	12" CC appliance pull	13-1/8"	5	AEM, BNBDL, DP, NI, SN	\$174.00



*Switching from
3" CC to 96 mm?*
Use Pull Escutcheons
to cover the old holes
See PE07 on page 148

JEFFREY ALEXANDER®

by Hardware Resources



Rae

Item	Description	Overall Length or Diameter	Ctn Qty	Finishes	List (each)
667S	small knob	1-1/16"	20	BNBDL, DBAC, NI, PC, SN	\$6.85
667	medium knob	1-1/4"	20	BNBDL, DBAC, NI, PC, SN	\$8.35
667L	large knob	1-3/8"	20	BNBDL, DBAC, NI, PC, SN	\$10.25
667-3	3" CC	3-7/16"	20	BNBDL, DBAC, NI, PC, SN	\$10.71
667-96	96 mm (3-3/4") CC	4-3/16"	20	BNBDL, DBAC, NI, PC, SN	\$14.50
667-128	128 mm (5-1/16") CC	5-1/2"	15	BNBDL, DBAC, NI, PC, SN	\$18.10
667-160	160 mm (6-5/16") CC	6-3/4"	10	BNBDL, DBAC, NI, PC, SN	\$21.85
667-224	224 mm (8-13/16") CC	9-1/4"	10	BNBDL, DBAC, NI, PC, SN	\$25.40
667-305	305 mm (12") CC	12-9/16"	10	BNBDL, DBAC, NI, PC, SN	\$60.25
667-12	12" CC appliance pull	12-13/16"	5	BNBDL, DBAC, NI, PC, SN	\$131.00
667-18	18" CC appliance pull	18-13/16"	5	BNBDL, DBAC, NI, PC, SN	\$165.00





Regan

Item	Description	Overall Length or Diameter	Ctn Qty	Finishes	List (each)
847-96	96 mm (3-3/4") CC	5-9/16"	25	BNBDL, DBAC, PC, SN	\$5.59
847-128	128 mm (5-1/16") CC	6-13/16"	25	BNBDL, DBAC, PC, SN	\$6.60
847-160	160 mm (6-5/16") CC	8-1/16"	25	BNBDL, DBAC, PC, SN	\$7.50



BNBDL
Brushed Pewter



DBAC
Brushed Oil
Rubbed Bronze



PC
Polished
Chrome



SN
Satin Nickel

JEFFREY ALEXANDER®

by Hardware Resources



Regency

Item	Description	Overall Length or Diameter	Ctn Qty	Finishes	List (each)
1097	acanthus knob	1-5/8"	25	ABSB, BNBDL, DBAC, SIM, SN	\$7.40
1099	plain knob	1-9/16"	25	ABSB, BNBDL, DBAC, SIM, SN	\$7.40
1098	96 mm (3-3/4") CC	4-1/2"	15	ABSB, BNBDL, DBAC, SIM, SN	\$11.81



ABSB
Antique Brushed
Satin Brass



BNBDL
Brushed Pewter



DBAC
Brushed Oil
Rubbed Bronze



SIM
Distressed
Antique Silver



SN
Satin Nickel

**Switching from
3" CC to 96 mm?**
Use Pull Escutcheons
to cover the old holes
See PE07 on page 148

JEFFREY ALEXANDER®

by Hardware Resources



Rhodes

Item	Description	Overall Length or Diameter	Ctn Qty	Finishes	List (each)
S6060	knob & backplate	1-1/4"	25	BNB, BNBDL, DACM, DBAC, SN	\$6.15
Z260-3	3" CC	3-3/4"	20	BNB, BNBDL, DACM, DBAC, SN	\$5.45
Z261-96	96 mm (3-3/4") CC	4-1/2"	20	BNB, BNBDL, DACM, DBAC, SN	\$5.90
B812-96R	96 mm (3-3/4") CC backplate	6"	30	ABSB, BNB, BNBDL, DACM, DBAC, ORB, SN	\$9.10
Z261-128	128 mm (5-1/16") CC	5-13/16"	15	BNB, BNBDL, DACM, DBAC, SN	\$16.15
Z260-12	12" CC appliance pull	13-1/4"	5	BNB, BNBDL, DACM, DBAC, SN	\$131.00



BNB
Brushed
Black Nickel



BNBDL
Brushed Pewter



DACM
Gun Metal



DBAC
Brushed Oil
Rubbed Bronze



SN
Satin Nickel

*Switching from
3" CC to 96 mm?*
Use Pull Escutcheons
to cover the old holes
See PE07 on page 148

JEFFREY ALEXANDER®

by Hardware Resources



Rochester

Item	Description	Overall Length or Diameter	Ctn Qty	Finishes	List (each)
155 [†]	knob	1-1/8"	30	ABSB, BNBDL, DBAC, SN	\$9.68
155-96 [†]	96 mm (3-3/4") CC	4-5/16"	25	ABSB, BNBDL, DBAC, SN	\$14.29
155-128 [†]	128 mm (5-1/16") CC	5-11/16"	10	ABSB, BNBDL, DBAC, SN	\$17.68



ABSB
Antique Brushed
Satin Brass



BNBDL
Brushed Pewter



DBAC
Brushed Oil
Rubbed Bronze



SN
Satin Nickel

*Switching from
3" CC to 96 mm?
Use Pull Escutcheons
to cover the old holes
See PE07 on page 148*





Royce

Item	Description	Overall Length or Diameter	Ctn Qty	Finishes	List (each)
431	knob (rounded)	1-3/16"	30	BNBDL, DBAC, PC, SN	\$5.59
595	knob (pyramid)	1-1/4"	20	BNBDL, DBAC, PC, SN	\$5.59
798-96	96 mm (3-3/4") CC	5-1/2"	10	BNBDL, DBAC, PC, SN	\$8.95
798-128	128 mm (5-1/16") CC	6-3/4"	10	BNBDL, DBAC, PC, SN	\$10.71
798-160	160 mm (6-5/16") CC	8-1/16"	10	BNBDL, DBAC, PC, SN	\$13.05





Solana

US Patent # D638,274; D638,275; D640,121

Item	Description	Overall Length or Diameter	Ctn Qty	Finishes	List (each)
457	square knob	1-1/4"	25	BN, PC NI, SN	\$16.38
457L	oblong knob	2"	25	BN, PC NI, SN	\$16.89
457-96	96 mm (3-3/4") CC	6"	10	BN, PC NI, SN	\$22.55

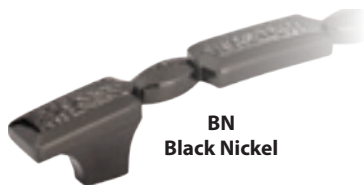



Sonoma

New finish

Item	Description	Overall Length or Diameter	Ctn Qty	Finishes	List (each)
431	knob	1-3/16"	30	BNBDL, DBAC, MB, PC, SN	\$5.59
4128	128 mm (5-1/16") CC	6-5/16"	20	BNBDL, DBAC, MB, PC, SN	\$10.99
4160	160 mm (6-5/16") CC	8"	20	BNBDL, DBAC, MB, PC, SN	\$13.35
4192	192 mm (7-9/16") CC	9-5/8"	10	BNBDL, DBAC, MB, PC, SN	\$19.68
4288	288 mm (11-3/8") CC	14-7/16"	10	BNBDL, DBAC, MB, PC, SN	\$92.25



BNBDL
Brushed
Pewter



DBAC
Brushed Oil
Rubbed Bronze



MB
Matte Black
NEW



PC
Polished
Chrome



SN
Satin Nickel

JEFFREY ALEXANDER®

by Hardware Resources



Sullivan

New Collection

Coming early 2019

Item	Description	Overall Length or Diameter	Ctn Qty	Finishes	List (each)
752-19	19 mm (3/4") CC	1-1/4"	25	BNBDL, DBAC, MB, PC, SN	\$6.53
752-96	96 mm (3-3/4") CC	4-1/2"	20	BNBDL, DBAC, MB, PC, SN	\$7.45
752-128	128 mm (5-1/16") CC	5-13/16"	10	BNBDL, DBAC, MB, PC, SN	\$9.99
752-160	160 mm (6-1/4") CC	7-1/16"	10	BNBDL, DBAC, MB, PC, SN	\$12.49
752-192	192 mm (7-9/16") CC	8-5/16"	10	BNBDL, DBAC, MB, PC, SN	\$14.99
752-224	224 mm (8 13/16") CC	9-9/16"	10	BNBDL, DBAC, MB, PC, SN	\$17.49



BNBDL
Brushed
Pewter



DBAC
Brushed Oil
Rubbed Bronze



MB
Matte Black



PC
Polished Chrome



SN
Satin Nickel



Sutton

New finishes

Item	Description	Overall Length or Diameter	Ctn Qty	Finishes	List (each)
635-32	32 mm (1-1/4") CC	2-1/4"	30	BG, BNBDL, DBAC, MB, NI, PC, SBZ, SN	\$8.72
635-96	96 mm (3-3/4") CC	4-3/4"	25	BG, BNBDL, DBAC, MB, NI, PC, SBZ, SN	\$10.65
635-128	128 mm (5-1/16") CC	5-7/8"	20	BG, BNBDL, DBAC, MB, NI, PC, SBZ, SN	\$12.75
635-160	160 mm (6-5/16") CC	7-1/2"	10	BG, BNBDL, DBAC, MB, NI, PC, SBZ, SN	\$15.40
635-256	256 mm (10-1/16") CC	11-7/16"	20	BG, BNBDL, DBAC, MB, NI, PC, SBZ, SN	\$35.89



JEFFREY ALEXANDER®

by Hardware Resources



Symphony

Item	Description	Overall Length or Diameter	Ctn Qty	Finishes	List (each)
1977S	knob	1-3/8"	30	ABSB, BNBDL, DACM, DBAC, SN	\$9.21
1976	ring pull & backplate	2"	20	ABSB, BNBDL, DACM, DBAC, SN	\$11.07
1977	96 mm (3-3/4") CC	4-9/16"	15	ABSB, BNBDL, DACM, DBAC, SN	\$11.65



ABSB
Antique Brushed
Satin Brass



BNBDL
Brushed
Pewter



DACM
Gun Metal



DBAC
Brushed Oil
Rubbed Bronze



SN
Satin Nickel

**Switching from
3" CC to 96 mm?**

Use Pull Escutcheons
to cover the old holes
See PE07 on page 148

JEFFREY ALEXANDER®

by Hardware Resources



Tahoe

US Patent # D602,330; D598,270

Item	Description	Overall Length or Diameter	Ctn Qty	Finishes	List (each)
602S	small knob	1-1/4"	30	BLK, DMAC, SIM	\$14.35
602	large knob	1-1/2"	25	BLK, DMAC, SIM	\$15.10
602-96	96 mm (3-3/4") CC	4-1/2"	10	BLK, DMAC, SIM	\$18.59
602-128	128 mm (5-1/16") CC	5-13/16"	10	BLK, DMAC, SIM	\$22.79
602-12	12" CC appliance pull	12-3/4"	5	BLK, DMAC, SIM	\$141.00



BLK
Black



DMAC
Distressed Oil
Rubbed Bronze



SIM
Distressed
Antique Silver

JEFFREY ALEXANDER®

by Hardware Resources



Tiffany

US Patent # D792,188

New finishes

Item	Description	Overall Length or Diameter	Ctn Qty	Finishes	List (each)
658	knob	1-1/4"	20	BG, BNBDL, DBAC, NI, PC, SBZ, SN	\$11.11
658-96	96 mm (3-3/4") CC	4-1/2"	20	BG, BNBDL, DBAC, NI, PC, SBZ, SN	\$15.05
658-128	128 mm (5-1/16") CC	5-13/16"	15	BG, BNBDL, DBAC, NI, PC, SBZ, SN	\$18.75
658-160	160 mm (6-5/16") CC	7-1/16"	10	BG, BNBDL, DBAC, NI, PC, SBZ, SN	\$22.95
658-192	192 mm (7-9/16") CC	8-3/8"	15	BG, BNBDL, DBAC, NI, PC, SBZ, SN	\$26.50
658-224	224 mm (8-13/16") CC	9-7/8"	15	BG, BNBDL, DBAC, NI, PC, SBZ, SN	\$30.35
658-12	12" CC appliance pull	13"	5	BG, BNBDL, DBAC, NI, PC, SBZ, SN	\$131.00



BG
Brushed Gold
NEW



BNBDL
Brushed Pewter



DBAC
Brushed Oil Rubbed Bronze



NI
Polished Nickel



PC
Polished Chrome



SBZ
Satin Bronze
NEW



SN
Satin Nickel



Tuscany

Item	Description	Overall Length or Diameter	Ctn Qty	Finishes	List (each)
749	knob	2-5/16"	25	ABSB, DACM, DBAC, SIM	\$7.30
749-96B	96 mm (3-3/4") CC	4-11/16"	10	ABSB, DACM, DBAC, SIM	\$9.79
749-128B	128 mm (5-1/16") CC	5-15/16"	10	ABSB, DACM, DBAC, SIM	\$10.50
749-128	128 mm (5-1/16") CC bail pull	5-15/16"	10	ABSB, DACM, DBAC, SIM	\$12.75
749-160	160 mm (6-5/16") CC bail pull	7-3/16"	25	ABSB, DACM, DBAC, SIM	\$16.38
749-224	224 mm (8-13/16") CC bail pull	9-3/4"	25	ABSB, DACM, DBAC, SIM	\$18.25



**Switching from
3" CC to 96 mm?**
Use Pull Escutcheons
to cover the old holes
See PE07 on page 148

JEFFREY ALEXANDER®

by Hardware Resources



Valencia

Item	Description	Overall Length or Diameter	Ctn Qty	Finishes	List (each)
80508 [‡]	knob	1-3/16"	30	ABSB, BNBDL, DBAC, SN	\$8.65
80509 [‡]	96 mm (3-3/4") CC	5-1/2"	15	ABSB, BNBDL, DBAC, SN	\$9.68

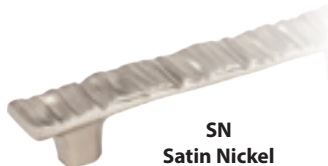



Venezia

Item	Description	Overall Length or Diameter	Ctn Qty	Finishes	List (each)
1095 [†]	knob	1-1/4"	20	AB, AEM, DACM, DBAC, SN	\$9.89
1096 [†]	96 mm (3-3/4") CC	5-3/4"	20	AB, AEM, DACM, DBAC, SN	\$14.99



AB
Brushed
Antique Brass



AEM
Lightly Distressed
Antique Brass



DACM
Gun Metal



DBAC
Brushed Oil
Rubbed Bronze



SN
Satin Nickel



These products are being retired.
Call for availability on products marked with "†".

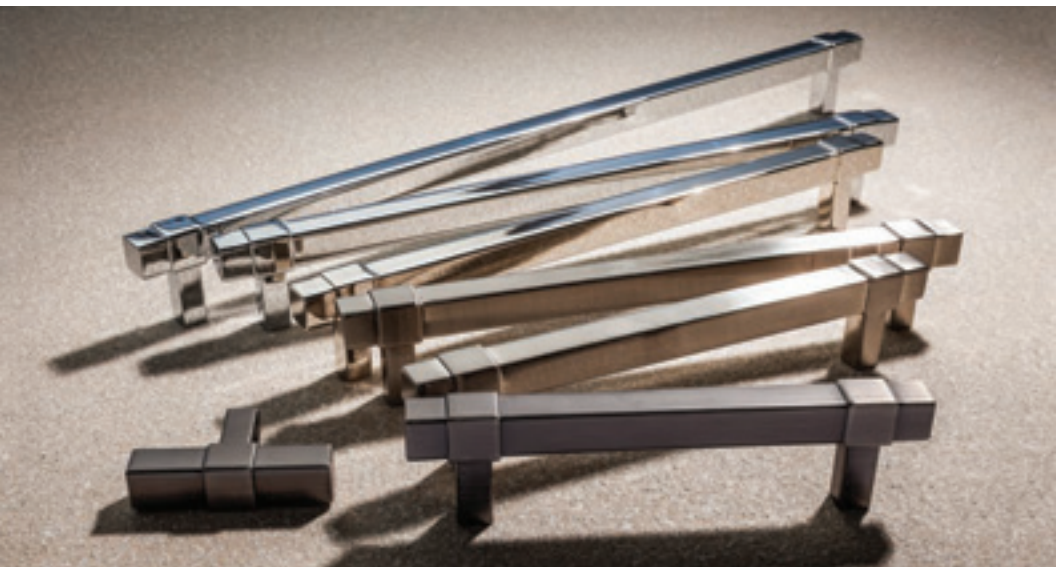

Zane

Item	Description	Overall Length or Diameter	Ctn Qty	Finishes	List (each)
293T	knob	2"	10	BNBDL, NI, PC, SN	\$8.68
293-96	96 mm (3-3/4") CC	5-1/16"	10	BNBDL, NI, PC, SN	\$13.20
293-128	128 mm (5-1/16") CC	6-5/16"	10	BNBDL, NI, PC, SN	\$15.35
293-160	160 mm (6-5/16") CC	7-9/16"	10	BNBDL, NI, PC, SN	\$17.79
293-192	192 mm (7-9/16") CC	8-13/16"	10	BNBDL, NI, PC, SN	\$20.58
293-224	224 mm (8-13/16") CC	10-1/16"	10	BNBDL, NI, PC, SN	\$23.50
293-305	305 mm (12") CC	13-1/4"	10	BNBDL, NI, PC, SN	\$60.25





Zurich

Item	Description	Overall Length or Diameter	Ctn Qty	Finishes	List (each)
I350	knob	2"	50	ABSB, DACM, DBAC, SIM	\$5.35
I300	3" CC	3-9/16"	20	ABSB, DACM, DBAC, SIM	\$9.59
I350-128	128 mm (5-1/16") CC bail pull	5-15/16"	15	ABSB, DACM, DBAC, SIM	\$13.50
I350-160	160 mm (6-5/16") CC bail pull	7-3/16"	10	ABSB, DACM, DBAC, SIM	\$15.40



Pull Escutcheons











P106-SB shown in use

1094SN shown in use

1094SN and PE03SN shown in use

Pull Escutcheons are a low profile transition from existing 3" CC holes to 96mm CC, or 4-1/4" CC to 128mm CC. Paired with our most popular cabinet pulls, they virtually disappear once installed. A second pair can be used on the inside of the cabinet door to cover the back of the original holes. Also works for 4-1/4" CC to 5" CC.

	Item	Coordinating Pulls	Ctn Qty	Finishes	List (each)
	PE01	415-96	50	ABSB, BNBDL, DACM, DBAC, SN	\$1.97
	PE02	146, 152, 156, 239, 317-96, 475, 537, 737-96, 818-96, 918-96, 1098, 3172, MO6273, Z290-96	50	ABM-D, ABSB, BNBDL, DACM, DBAC, DMAC, SIM, SN	\$1.97
	PE03	155-96, 188-96, 293-96, 596, 885-96, 910-96, 1092, 1094, Z261-96	50	AB, ABSB, AEM, BNBDL, DACM, DBAC, PC, SBN, SN	\$1.97
	PE04	527, 658-96, 749-96B	50	ABM-D, ABSB, DACM, DBAC, SIM	\$1.97
	PE05	959-96	50	ABSB, BNBDL, DBAC	\$1.97
	PE06	519-96, 650-96	50	ABSB, BNBDL, DBAC, NI, SN	\$1.97
	PE07	MO6373	50	ABM-D, DACM, DMAC, SIM-D	\$1.97
	PE08	123-96, 125-96, 1977	50	ABSB, BNBDL, DACM, DBAC, SN	\$1.97



DG01 drill guide with 96mm CC holes and with nibs that fit into 3" CC holes
Use for centering 96mm CC holes over 3" CC holes

Backplates



B812-96R-BNB



B812-96SN



B812SN

B812-96SN and MO6373SN shown in use

Item	Description	Overall Length	Width	Ctn Qty	Finishes	List (each)
B812	plain knob backplate	2-13/16"	1"	50	AB, ABM-D, ABSB, AEM, ASM, BC, BLK, BNB, BNBDL, DACM, DBAC, ORB, PC, SB, SBN, SN	\$5.29
B812-96	plain 96mm CC backplate	6"	1-1/4"	30	AB, ABM-D, ABSB, AEM, ASM, BC, BK, BNB, BNBDL, DACM, DBAC, ORB, PC, SB, SBN, SN	\$9.10
B812-96R	rope 96mm CC backplate	6"	1-1/4"	30	ABSB, BNB, BNBDL, DACM, DBAC, ORB, SN	\$9.10



AB
Brushed
Antique Brass



ABM-D
Distressed
Antique Brass



ABSB
Antique Brushed
Satin Brass



AEM
Lightly
Distressed
Antique Brass



ASM
Distressed
Antique Silver



BC
Brushed
Chrome



BLK
Matte Black



BNB
Brushed Black
Nickel



BNBDL
Brushed
Pewter



DACM
Gun Metal



DBAC
Brushed Oil
Rubbed Bronze



ORB
Dark Bronze



PC
Polished
Chrome



SB
Satin Brass



SBN
Satin Black
Nickel



SN
Satin Nickel

Latches & Finial Hinges



CL101SN shown in use



CL101DBAC
DBAC
Brushed Oil
Rubbed Bronze



CL101NI
NI
Polished Nickel



CL101SN
SN
Satin Nickel

Item	Description	Height	Ctn Qty	Finishes	List (each)
CL101	Cabinet Latch 1-3/4"	-	25	DBAC, NI, SN	\$13.95



0138DBAC
DBAC
Brushed Oil Rubbed Bronze



0178SN
SN
Satin Nickel



0148MB
MB
Matte Black



0158NI
NI
Polished Nickel



0128AB
AB
Antique Brass

Item	Description	Height	Ctn Qty	Finishes	List (each)
0128	Full Wrap Around Hinge, sold individually	2-3/4"	250	AB, MB, SN	\$1.39
0128DBAC	Full Wrap Around Hinge, sold individually	2-3/4"	250	DBAC	\$1.59
0138	Full Wrap Around Hinge, sold individually	2-3/4"	20	DBAC, MB, NI, SN	\$3.19
0148	Partial Wrap Around Hinge, sold individually	2-3/4"	250	AB, MB, SN	\$1.59
0148DBAC	Partial Wrap Around Hinge, sold individually	2-3/4"	250	DBAC	\$1.76
0158	Partial Wrap Around Hinge, sold individually	2-3/4"	50	DBAC, NI, SN	\$3.19
0178	Partial Wrap Around Hinge, sold individually	4"	50	DBAC, NI, SN	\$3.91

The **essentials** and more, priced right



Over 40 designs of knobs and pulls in the most popular styles and finishes

Complete line of steel bar pulls available in the Naples collection

Base metal of cast zinc alloy, steel, aluminum or stainless steel for durability

Machine polished for consistent quality

Also ideal for the commercial, multi-family, retail and builder markets

Lifetime Warranty



Aiden

Item	Description	Overall Length or Diameter	Ctn Qty	Finishes	List (each)
993	knob	1-5/8"	30	BNBDL, DBAC, PC, SN	\$3.38
993-3	3" CC	4-1/16"	25	BNBDL, DBAC, PC, SN	\$5.50
993-96	96 mm (3-3/4") CC	4-3/4"	20	BNBDL, DBAC, PC, SN	\$6.63
993-128	128 mm (5-1/16") CC	6-1/8"	15	BNBDL, DBAC, PC, SN	\$8.59





Arcadia

Item	Description	Overall Length or Diameter	Ctn Qty	Finishes	List (each)
107	knob	1-5/16"	25	AEM, ASM, BNBDL, DACM, DBAC, ORB, PC, SN	\$5.25
516	3" CC	5-1/2"	25	AEM, ASM, BNBDL, DACM, DBAC, ORB, PC, SN	\$5.25

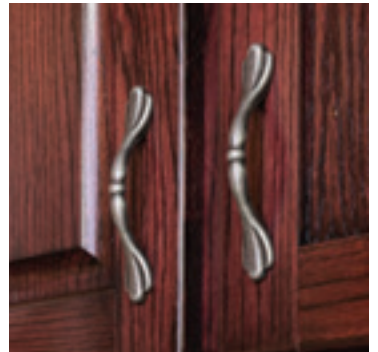



Asher

Item	Description	Overall Length or Diameter	Ctn Qty	Finishes	List (each)
193-3	3" CC	3-1/4"	15	BC, BNBDL, DBAC, PC, SN	\$6.60
193-96	96 mm (3-3/4") CC	4"	15	BC, BNBDL, DBAC, PC, SN	\$7.25
193-4	4" CC	4-1/4"	15	BC, BNBDL, DBAC, PC, SN	\$7.85
193-128	128 mm (5-1/16") CC	5-1/4"	10	BC, BNBDL, DBAC, PC, SN	\$8.87
193-160	160 mm (6-5/16") CC	6-9/16"	10	BC, BNBDL, DBAC, PC, SN	\$10.34

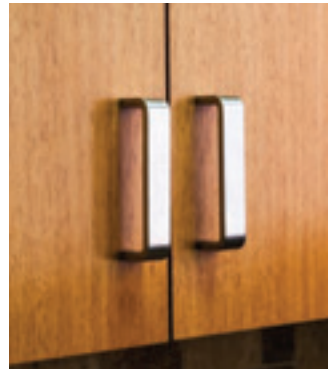



Belfast

Item	Description	Overall Length or Diameter	Ctn Qty	Finishes	List (each)
308-128	128 mm (5-1/16") CC	5-9/16"	25	BLK, DN, PC, SN	\$5.75
406-128	128 mm (5-1/16") CC	6-9/16"	20	BLK, DN, PC, SN	\$8.78
745-128	128 mm (5-1/16") CC	5-11/16"	20	BLK, DN, PC, SN	\$7.01
776-128	128 mm (5-1/16") CC	5-11/16"	20	BLK, DN, PC, SN	\$8.38
976-128	128 mm (5-1/16") CC	6-3/16"	20	BLK, DN, PC, SN	\$7.60



BLK
Matte Black



DN
Dull Nickel



PC
Polished
Chrome



SN
Satin Nickel





Brenton

Item	Description	Overall Length or Diameter	Ctn Qty	Finishes	List (each)
239	knob	1"	30	BC, BNBDL, DACM, DBAC, PC, SN	\$4.33
239-96	96 mm (3-3/4") CC	4-5/16"	15	BC, BNBDL, DACM, DBAC, PC, SN	\$6.45
239-128	128 mm (5-1/16") CC	5-9/16"	15	BC, BNBDL, DACM, DBAC, PC, SN	\$8.35
239-160	160 mm (6-5/16") CC	6-13/16"	15	BC, BNBDL, DACM, DBAC, PC, SN	\$9.79
239-192	192 mm (7-9/16") CC	8-1/16"	10	BC, BNBDL, DACM, DBAC, PC, SN	\$10.71





Calloway

Item	Description	Overall Length or Diameter	Ctn Qty	Finishes	List (each)
331	small round knob	1-1/8"	25	BNBDL, DBAC, PC, SN	\$3.65
351	small square knob	1-1/8"	25	BNBDL, DBAC, PC, SN	\$3.95
331L	large round knob	1-1/4"	25	BNBDL, DBAC, PC, SN	\$4.58
351L	large square knob	1-1/4"	25	BNBDL, DBAC, PC, SN	\$4.91
331-96	96 mm (3-3/4") CC	4-1/2"	15	BNBDL, DBAC, PC, SN	\$6.79
351-96	96 mm (3-3/4") CC	4-7/16"	15	BNBDL, DBAC, PC, SN	\$7.25
331-128	128 mm (5-1/16") CC	5-3/4"	10	BNBDL, DBAC, PC, SN	\$7.50
351-128	128 mm (5-1/16") CC	5-11/16"	10	BNBDL, DBAC, PC, SN	\$7.92

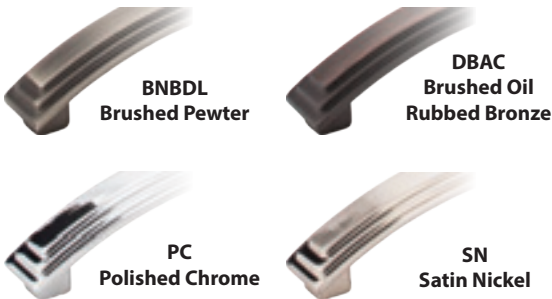

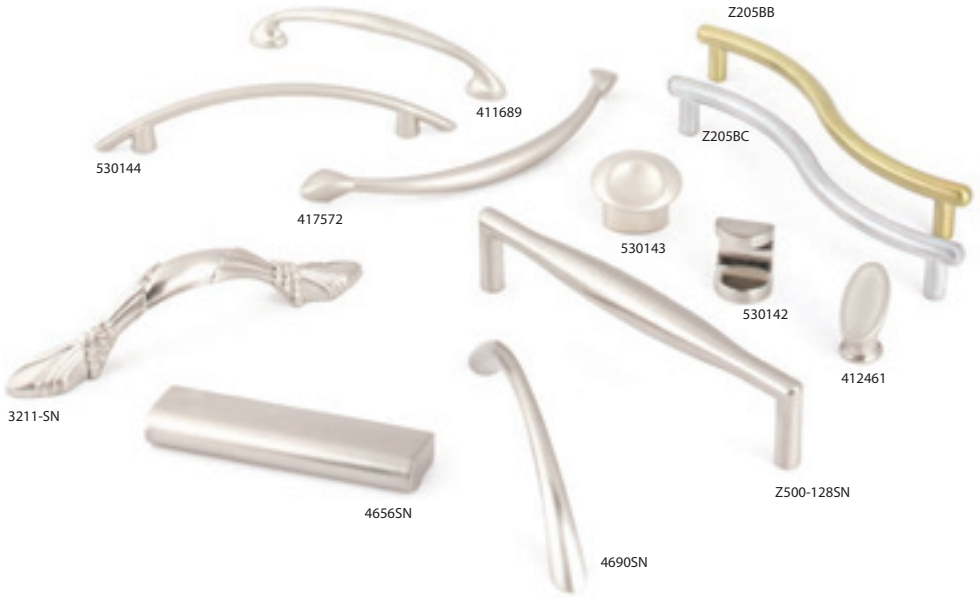

Capri

Item	Description	Overall Length or Diameter	Ctn Qty	Finishes	List (each)
412461	knob	1-1/16"	50	SN	\$3.41
530142	knob	13/16"	25	SN	\$3.41
530143	knob	1-1/4"	25	DN	\$3.41
3211	3" CC	4-15/16"	25	SN	\$4.05
4656	3" CC	3-3/8"	25	SN	\$5.45
411689*	96 mm (3-3/4") CC	4-3/8"	50	DN	\$3.86
4690	96 mm (3-3/4") CC	4-1/2"	50	SN	\$3.98
530144	96 mm (3-3/4") CC	5-1/8"	50	DN	\$3.41
417572	128 mm (5-1/16") CC	5-1/2"	30	DN	\$5.09
Z205	128 mm (5-1/16") CC	5-3/4"	30	BB, BC	\$5.90
Z500-128	128 mm (5-1/16") CC	5-5/8"	15	SN	\$11.85



BB Brushed Brass
BC Brushed Chrome
DN Dull Nickel
SN Satin Nickel

*M4 attachment screws included with 411689 pull

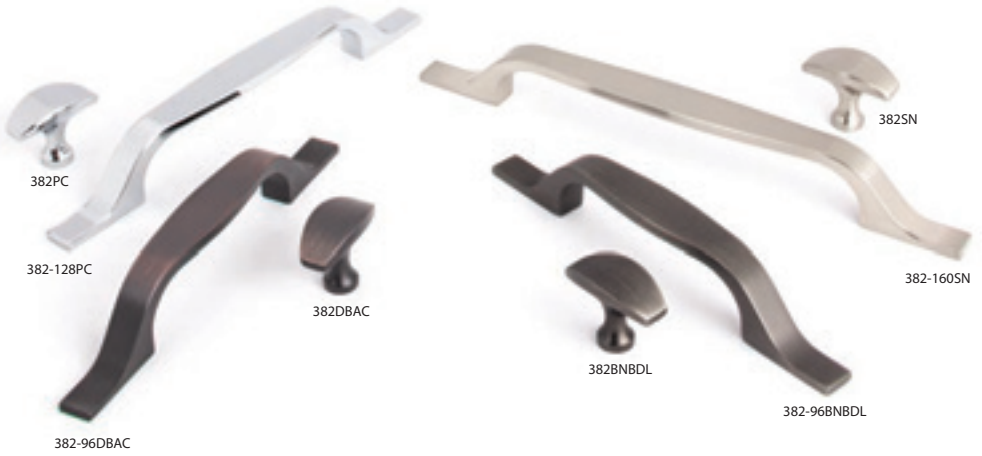

Cosgrove

Item		Overall Length or Diameter	Ctn Qty	Finishes	List (each)
382	knob	1-1/2"	25	BNBDL, DBAC, PC, SN	\$3.71
382-96	96 mm (3-3/4") CC	6-1/2"	15	BNBDL, DBAC, PC, SN	\$8.81
382-128	128 mm (5-1/16") CC	7-3/4"	10	BNBDL, DBAC, PC, SN	\$10.18
382-160	160 mm (6-5/16") CC	9"	10	BNBDL, DBAC, PC, SN	\$11.75

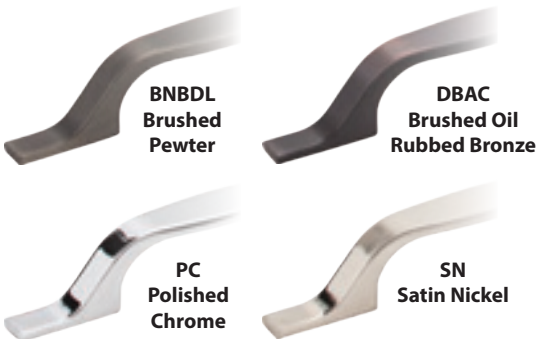



Cypress

Item	Description	Overall Length or Diameter	Ctn Qty	Finishes	List (each)
Z118	knob	1-1/4"	25	BNBDL, DACM, DBAC, SN	\$2.62
Z118-3	3" CC	3-3/8"	20	BNBDL, DACM, DBAC, SN	\$3.30
Z118-96	96 mm (3-3/4") CC	4-1/8"	20	BNBDL, DACM, DBAC, SN	\$3.71





Drake

Item	Description	Overall Length or Diameter	Ctn Qty	Finishes	List (each)
423	faceted knob	1-3/16"	30	BNBDL, DACM, DBAC, PC, SN	\$4.97
424	flat top knob	1-3/16"	25	BNBDL, DACM, DBAC, PC, SN	\$5.29
423-3	3" CC	4"	25	BNBDL, DACM, DBAC, PC, SN	\$5.35
423-96	96 mm (3-3/4") CC	4-3/4"	20	BNBDL, DACM, DBAC, PC, SN	\$6.32

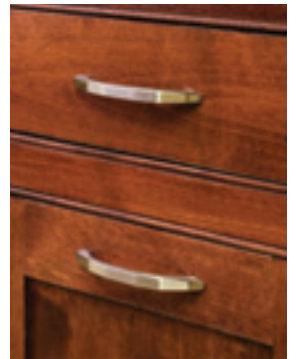
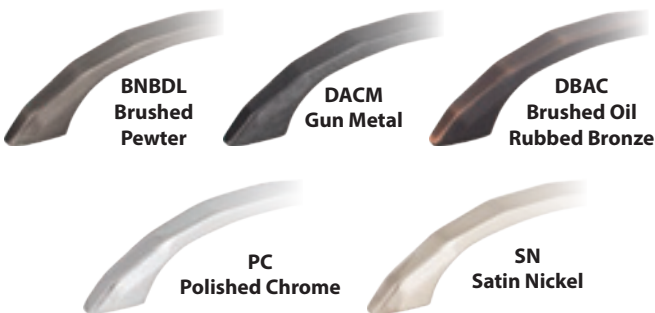

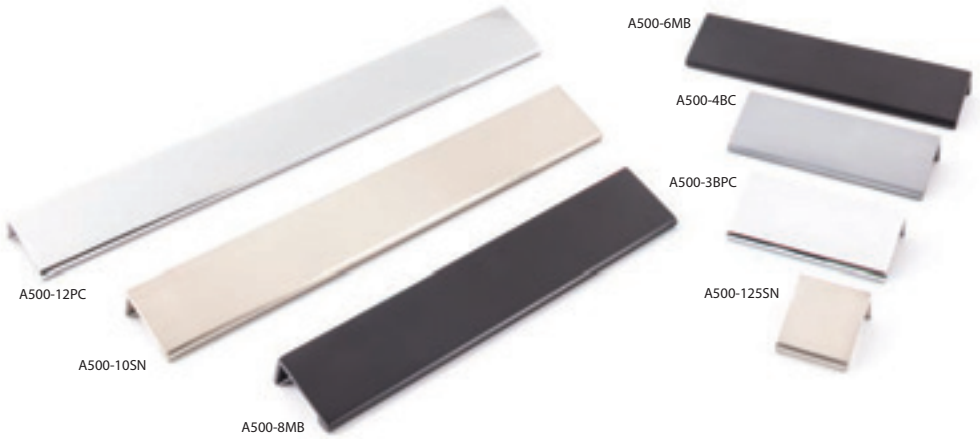

Edgefield

Item	Description	Overall Length	Ctn Qty	Finishes	List (each)
A500-125*	16 mm (5/8") CC tab pull	1-1/4"	50	BC, MB, PC, SN	\$4.05
A500-3*	60 mm (2-3/8") CC tab pull	3"	25	BC, MB, PC, SN	\$5.59
A500-4*	76 mm (2-15/16") CC tab pull	4"	25	BC, MB, PC, SN	\$6.89
A500-6*	127 mm (5") CC tab pull	6"	20	BC, MB, PC, SN	\$9.68
A500-8*	90 mm (3-9/16") CC tab pull (3 holes)	8"	20	BC, MB, PC, SN	\$12.45
A500-10*	114 mm (4-1/2") CC tab pull (3 holes)	10"	10	BC, MB, PC, SN	\$15.35
A500-12*	90 mm (3-9/16") CC tab pull (4 holes)	12"	50	BC, MB, PC, SN	\$18.50

*Wood screws included with all tab pulls

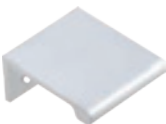
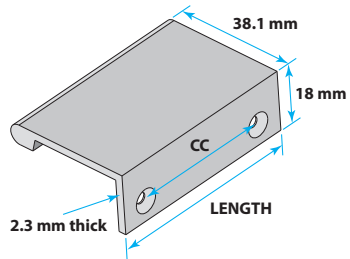

BC
Brushed Chrome

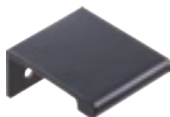

MB
Matte Black



PC
Polished Chrome

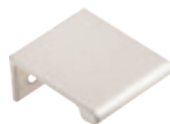

SN
Satin Nickel



Florence

New finishes

Item	Description	Overall Length or Diameter	Ctn Qty	Finishes	List (each)
2980	knob	1-1/4"	20	AB, BNBDL, DACM, DBAC, MB, ORB, PC, SBZ, SN	\$5.39
2981	3" CC cup pull	3-11/16"	20	AB, BNBDL, DACM, DBAC, MB, ORB, PC, SBZ, SN	\$7.07





Gatsby

Item	Description	Overall Length or Diameter	Ctn Qty	Finishes	List (each)
3940	knob	1-3/16"	50	BNBDL, DACM, DBAC, PC, SN	\$2.38
3950	knob	1-3/16"	50	BNBDL, DACM, DBAC, PC, SN	\$2.22
3960	knob	1-1/4"	25	BNBDL, DACM, DBAC, PC, SN	\$3.18
3970	knob	1-1/8"	25	BNBDL, DACM, DBAC, PC, SN	\$2.75
3108	3" CC	5-1/4"	25	BNBDL, DACM, DBAC, PC, SN	\$3.35
3208	3" CC	4-1/4"	25	BNBDL, DACM, DBAC, PC, SN	\$3.71
3308	3" CC	4-1/2"	25	BNBDL, DACM, DBAC, PC, SN	\$3.65









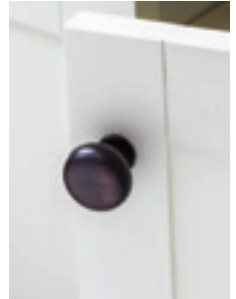











Geneva

Item	Description	Overall Length or Diameter	Ctn Qty	Finishes	List (each)
3915	knob	1"	50	AB [†] , BNBDL, DACM, DBAC, PB [†] , PC, SN	\$2.50
S802 [†]	knob	1-1/4"	25	DACM, DBAC, ORB, SN	\$4.55
Z6001 [†]	knob	1-1/4"	25	DACM, DBAC, PB, PC, SN	\$5.20



3915					N/A			
S802	N/A	N/A				N/A	N/A	
Z6001	N/A	N/A			N/A			
	AB Brushed Antique Brass	BNBDL Brushed Pewter	DACM Gun Metal	DBAC Brushed Oil Rubbed Bronze	ORB Dark Bronze	PB Polished Brass	PC Polished Chrome	SN Satin Nickel



These products are being retired.
Call for availability on products marked with "†".



Glendale

New finishes

Item	Description	Overall Length or Diameter	Ctn Qty	Finishes	List (each)
525	knob	1-1/8"	50	ABM-D, BNBDL, DBAC, DMAC, MB, PC, SIM, SBZ, SN	\$4.83
525-96	96 mm (3-3/4") CC	4-15/16"	25	ABM-D, BNBDL, DBAC, DMAC, MB, PC, SIM, SBZ, SN	\$6.20

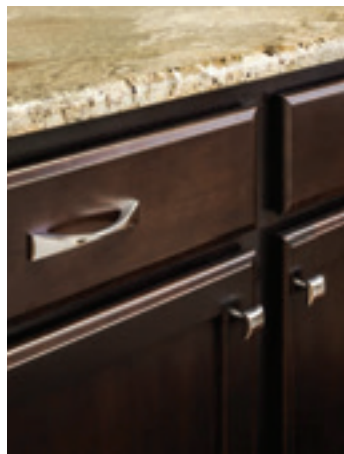

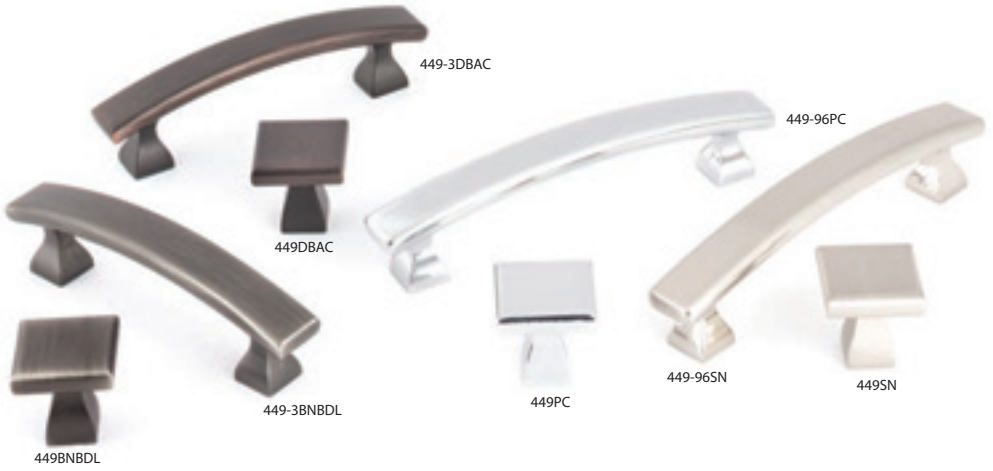

Hadly

US Patent # D833,249; D833,252

Item	Description	Overall Length or Diameter	Ctn Qty	Finishes	List (each)
449	knob	1"	25	BNBDL, DBAC, PC, SN	\$4.58
449-3	3" CC	4"	15	BNBDL, DBAC, PC, SN	\$6.60
449-96	96 mm (3-3/4") CC	4-3/4"	15	BNBDL, DBAC, PC, SN	\$7.55



BNBDL
Brushed
Pewter



DBAC
Brushed Oil
Rubbed Bronze



PC
Polished
Chrome



SN
Satin Nickel





Hammond

Item	Description	Overall Length or Diameter	Ctn Qty	Finishes	List (each)
525	knob	1-1/8"	50	BNBDL, DBAC, PC, SN	\$4.83
937-3	3" CC	4-7/8"	20	BNBDL, DBAC, PC, SN	\$3.86
937-96	96 mm (3-3/4") CC	5-11/16"	20	BNBDL, DBAC, PC, SN	\$5.59



BNBDL
Brushed
Pewter



DBAC
Brushed Oil
Rubbed Bronze



PC
Polished
Chrome



SN
Satin
Nickel





Kenner

Item	Description	Overall Length or Diameter	Ctn Qty	Finishes	List (each)
3970	knob	1-1/8"	25	BNBDL, DBAC, PC, SN	\$2.75
254-3	3" CC	5"	20	BNBDL, DBAC, PC, SN	\$3.86
254-96	96 mm (3-3/4") CC	5-3/4"	20	BNBDL, DBAC, PC, SN	\$5.59

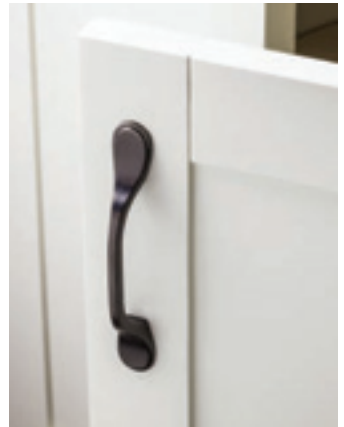



Kingsport

Item	Description	Overall Length or Diameter	Ctn Qty	Finishes	List (each)
202	knob	1-1/4"	50	AB	\$2.38
875	knob	1-5/16"	100	AB	\$1.57
878	knob	1-3/16"	50	AE	\$3.41
WK150	knob	1-1/4"	100	AB	\$2.75
840	3" CC	4-3/4"	50	AB	\$3.18
1018	3" CC	4-3/8"	25	AB	\$3.11
3208	3" CC	4-1/4"	25	AB	\$3.11
4655	128 mm (5-1/16") CC	6-1/4"	25	AB	\$5.90
CH3503	3-1/2" CC	4-3/4"	25	AB	\$5.45
WP150	3" CC	4-1/4"	25	AB	\$7.25
WB150*	4-1/2" CC	6"	50	AB	\$3.41

*Two attachment nails included with WB150 backplate

AB Brushed Antique Brass
AE Antique Brass

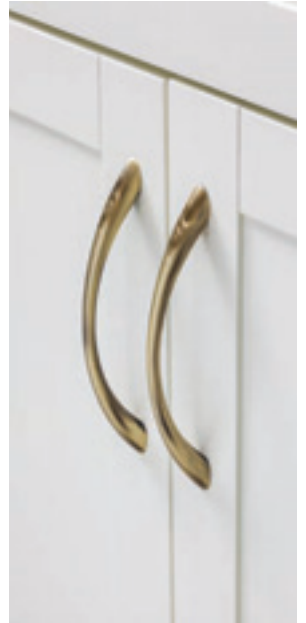



Lindos

Item	Description	Overall Length or Diameter	Ctn Qty	Finishes	List (each)
Z115	round knob	1-1/4"	25	BNBDL, DBAC, PC, SN	\$4.33
Z115L	oblong knob	1-3/8"	25	BNBDL, DBAC, PC, SN	\$3.98
Z115-96	96 mm (3-3/4") CC	4-3/8"	20	BNBDL, DBAC, PC, SN	\$5.06
Z115-128	128 mm (5-1/16") CC	5-9/16"	15	BNBDL, DBAC, PC, SN	\$13.45





Luxe

US Patent # D570,186; D570,183

Item	Description	Overall Length or Diameter	Ctn Qty	Finishes	List (each)
323 ^F	knob	1-3/16"	30	BNBDL, DBAC, SN	\$3.11
323-96 ^F	96 mm (3-3/4") CC	6"	25	BNBDL, DBAC, SN	\$5.09

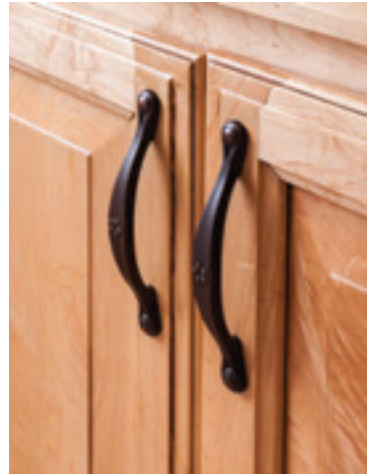



Madison

New finishes

Item	Description	Overall Length or Diameter	Ctn Qty	Finishes	List (each)
3910	knob	1-3/16"	30	AB, ALM, BC, BG, BN, BNBDL, DACM, DBAC, MB, ORB, PB, PC, SB, SBZ, SN, WH	\$3.56
Z259-3	3" CC	3-3/8"	50	AB, BC, BN, BNBDL, DACM, DBAC, MB, ORB, PB, PC, SB, SBZ, SSN	\$4.05
Z259-12	12" CC appliance pull	13"	5	AB, BC, BN, DACM, DBAC, ORB, PC, SN	\$131.00



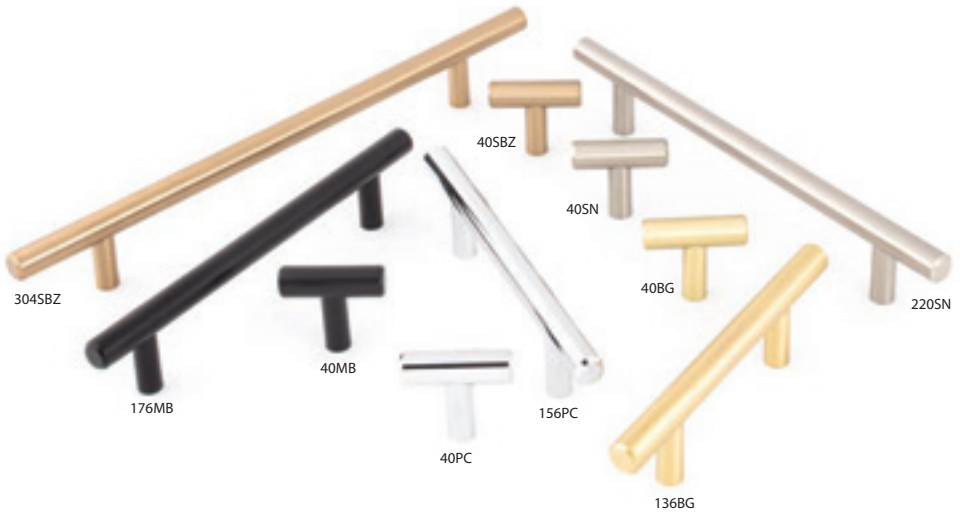

Naples

New finishes

Item	Description	Overall Length or Diameter	Ctn Qty	Material	Finishes	List (each)
40	T knob	1-9/16"	30	Steel	BG, MB, PC, SBZ, SN	\$3.78
136	3" CC	5-3/8"	10	Steel	BG, MB, PC, SBZ, SN	\$5.06
156	96 mm (3-3/4") CC	6-1/8"	10	Steel	BG, MB, PC, SBZ, SN	\$6.20
176	128 mm (5-1/16") CC	6-15/16"	10	Steel	BG, MB, PC, SBZ, SN	\$7.50
206	128 mm (5-1/16") CC	8-1/8"	10	Steel	BG, MB, PC, SBZ, SN	\$9.35
220	160 mm (6-5/16") CC	8-11/16"	10	Steel	BG, MB, PC, SBZ, SN	\$8.25
272	192 mm (7-9/16") CC	10-11/16"	10	Steel	BG, MB, PC, SBZ, SN	\$9.49
304	224 mm (8-13/16") CC	11-15/16"	10	Steel	BG, MB, PC, SBZ, SN	\$10.29
336	256 mm (10-1/16") CC	13-1/4"	10	Steel	BG, MB, PC, SBZ, SN	\$11.25
368	288 mm (11-5/16") CC	14-1/2"	10	Steel	BG, MB, PC, SBZ, SN	\$12.10
399	319 mm (12-9/16") CC	15-11/16"	10	Steel	BG, MB, PC, SBZ, SN	\$13.15
496	416 mm (16-1/2") CC	19-1/2"	10	Steel	BG, MB, PC, SBZ, SN	\$15.80
560	480 mm (18-7/8") CC	22-1/16"	10	Steel	PC, SN	\$17.60
624	544 mm (21-7/16") CC	24-9/16"	10	Steel	PC, SN	\$19.50
720	640 mm (25-3/16") CC	28-3/8"	10	Steel	PC, SN	\$22.39
763	673 mm (26-1/2") CC	30-1/16"	10	Steel	PC, SN	\$23.68



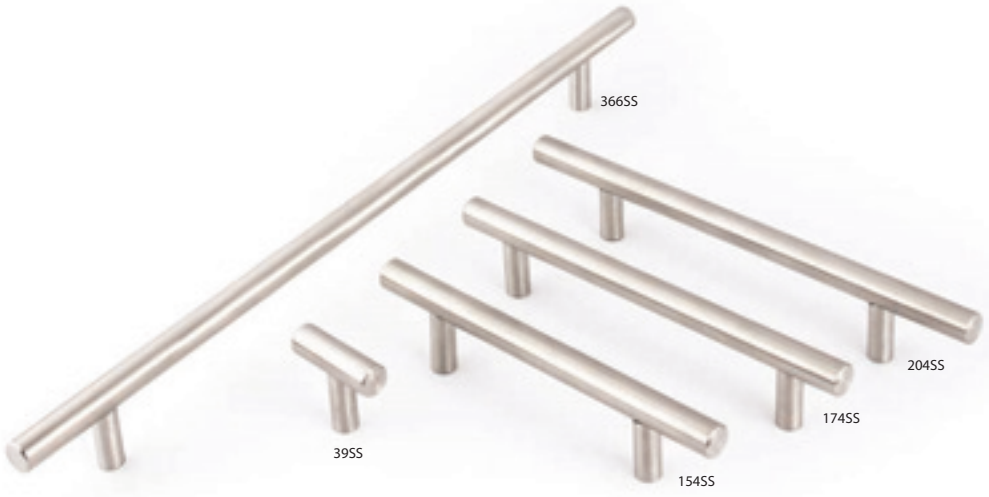

Naples

Item	Description	Overall Length or Diameter	Ctn Qty	Material	Finishes	List (each)
39	T knob	1-1/2"	40	Hollow Stainless Steel	SS	\$3.18
154	96 mm (3-3/4") CC	6-1/16"	20	Hollow Stainless Steel	SS	\$4.75
174	128 mm (5-1/16") CC	6-7/8"	20	Hollow Stainless Steel	SS	\$6.20
204	128 mm (5-1/16") CC	8"	20	Hollow Stainless Steel	SS	\$8.27
270	192 mm (7-9/16") CC	10-5/8"	20	Hollow Stainless Steel	SS	\$8.85
302	224 mm (8-13/16") CC	11-7/8"	20	Hollow Stainless Steel	SS	\$9.53
334	256 mm (10-1/16") CC	13-1/8"	20	Hollow Stainless Steel	SS	\$9.89
366	288 mm (11-5/16") CC	14-7/16"	10	Hollow Stainless Steel	SS	\$10.75
397	319 mm (12-9/16") CC	15-5/8"	10	Hollow Stainless Steel	SS	\$11.85
494	416 mm (16-1/2") CC	19-7/16"	10	Hollow Stainless Steel	SS	\$14.55
558	480 mm (18-7/8") CC	22"	10	Hollow Stainless Steel	SS	\$16.15
622	544 mm (21-7/16") CC	24-1/2"	10	Hollow Stainless Steel	SS	\$17.60
719	640 mm (25-3/16") CC	28-5/16"	10	Hollow Stainless Steel	SS	\$19.89
761	673 mm (26-1/2") CC	29-15/16"	10	Hollow Stainless Steel	SS	\$21.30



SS
Stainless Steel



Merryville

Item	Description	Overall Length or Diameter	Ctn Qty	Finishes	List (each)
897	small egg knob	1-1/8"	20	BNBDL, DBAC, PC, SN	\$3.56
897L	large egg knob	1-1/4"	20	BNBDL, DBAC, PC, SN	\$3.98
897-3	3" CC	5-1/8"	20	BNBDL, DBAC, PC, SN	\$4.33



BNBDL
Brushed
Pewter



DBAC
Brushed Oil
Rubbed Bronze



PC
Polished
Chrome



SN
Satin Nickel



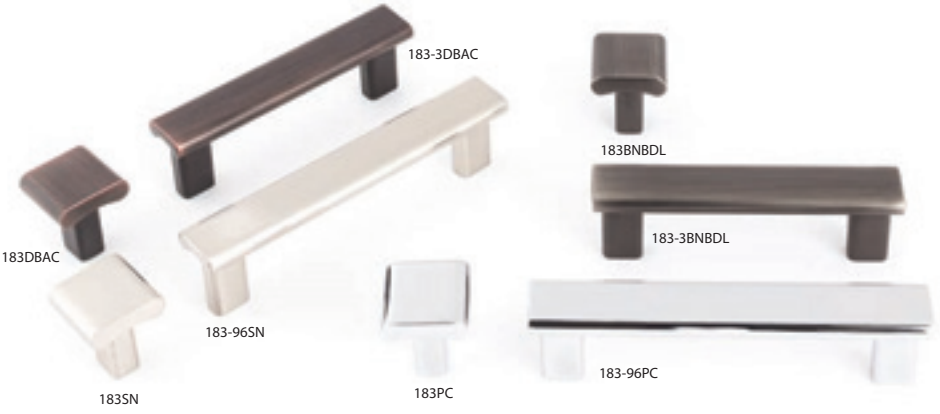

Park

US Patent # D833,250; D833,253

Item	Description	Overall Length or Diameter	Ctn Qty	Finishes	List (each)
183	knob	1"	25	BNBDL, DBAC, PC, SN	\$4.58
183-3	3" CC	3-3/4"	15	BNBDL, DBAC, PC, SN	\$6.60
183-96	96 mm (3-3/4") CC	4-1/2"	15	BNBDL, DBAC, PC, SN	\$7.55



BNBDL
Brushed
Pewter



DBAC
Brushed Oil
Rubbed Bronze



PC
Polished Chrome



SN
Satin Nickel





Seaver

Item	Description	Overall Length or Diameter	Ctn Qty	Finishes	List (each)
511	knob	1-1/4"	25	BNBDL, DBAC, PC, SN	\$4.05
511-3	3" CC	4-1/16"	15	BNBDL, DBAC, PC, SN	\$6.20
511-96	96 mm (3-3/4") CC	4-7/8"	15	BNBDL, DBAC, PC, SN	\$6.75





Sedona

Item	Description	Overall Length or Diameter	Ctn Qty	Finishes	List (each)
26	knob	1"	30	SN	\$4.33
400	3" CC	4"	10	SN	\$7.01
475	96 mm (3-3/4") CC	4-3/4"	10	SN	\$8.78
600	128 mm (5-1/16") CC	6"	10	SN	\$12.10





Slade

Item	Description	Overall Length or Diameter	Ctn Qty	Finishes	List (each)
3915	knob	1"	50	BNBDL, DACM, DBAC, PC, SN	\$2.50
984-3	3" CC	3-1/2"	30	BNBDL, DACM, DBAC, PC, SN	\$4.50
984-96	96 mm (3-3/4") CC	4-1/4"	25	BNBDL, DACM, DBAC, PC, SN	\$5.18
984-128	128 mm (5") CC	5-1/2"	25	BNBDL, DACM, DBAC, PC, SN	\$5.90
984-160	160 mm (6-5/16") CC	6-3/4"	15	BNBDL, DACM, DBAC, PC, SN	\$6.85
984-192	192 mm (7-9/16") CC	8"	15	BNBDL, DACM, DBAC, PC, SN	\$7.82





Somerset

Item	Description	Overall Length or Diameter	Ctn Qty	Finishes	List (each)
8004	96 mm (3-3/4") CC	4-7/8"	30	BNBDL, DBAC, PC, SN	\$4.65
81065	128 mm (5-1/16") CC	6"	25	BNBDL, DBAC, PC, SN	\$5.55
80814	96 mm (3-3/4") CC	5"	30	BNBDL, DBAC, PC, SN	\$3.71
80815	128 mm (5-1/16") CC	6-5/16"	25	BNBDL, DBAC, PC, SN	\$5.55



BNBDL
Brushed
Pewter



DBAC
Brushed Oil
Rubbed Bronze



PC
Polished
Chrome



SN
Satin Nickel





Stanton

New Finishes

Item	Description	Overall Length or Diameter	Ctn Qty	Finishes	List (each)
625-3	3" CC	3-3/8"	20	BG, MB, MS, PC, SBZ, SN	\$6.32
625-96	96 mm (3-3/4") CC	4-1/8"	25	BG, MB, MS, PC, SBZ, SN	\$7.60
625-128	128 mm (5-1/16") CC	5-3/8"	20	BG, MB, MS, PC, SBZ, SN	\$8.87
625-160	160 mm (6-5/16") CC	6-5/8"	10	BG, MB, MS, PC, SBZ, SN	\$10.65
625-192	192 mm (7-9/16") CC	7-15/16"	10	BG, MB, MS, PC, SBZ, SN	\$12.15
625-224	224 mm (8-13/16") CC	9-3/16"	10	BG, MB, MS, PC, SBZ, SN	\$13.85
625-320	320 mm (12-5/8") CC	12-15/16"	10	BG, MB, MS, PC, SBZ, SN	\$18.95
625-448	448 mm (17-5/8") CC	18"	10	BG, MB, MS, PC, SBZ, SN	\$25.49





Strickland

Item	Description	Overall Length or Diameter	Ctn Qty	Finishes	List (each)
771-3	3" CC	4-1/2"	20	BNBDL, DBAC, PC, SN	\$6.36
771-96	96 mm (3-3/4") CC	5-3/16"	20	BNBDL, DBAC, PC, SN	\$7.15
771-128	128 mm (5-1/16") CC	6-5/16"	20	BNBDL, DBAC, PC, SN	\$8.35
771-160	160 mm (6-5/16") CC	7-11/16"	20	BNBDL, DBAC, PC, SN	\$9.89





Syracuse

Item	Description	Overall Length or Diameter	Ctn Qty	Finishes	List (each)
575	knob	1-3/16"	30	BNBDL, DBAC, PC, SN	\$3.65
575-96	96 mm (3-3/4") CC	4-7/8"	20	BNBDL, DBAC, PC, SN	\$7.25

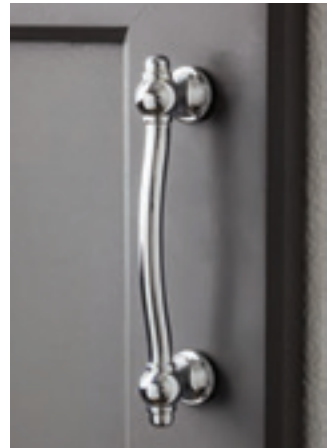



Torino

AL	Aluminum	PB	Polished Brass
ALM	Almond	PC	Polished Chrome
BC	Brushed Chrome	SN	Satin Nickel
DBAC	Brushed Oil Rubbed Bronze	WH	White

Item	Description	Overall Length or Diameter	Ctn Qty	Material	Finishes	List (each)
A271-3AL	3" CC	3-5/16"	30	Aluminum	AL	\$1.86
K271-3SS	3" CC	3-5/16"	30	Stainless Steel	SS	\$5.45
S271-3	3" CC	3-5/16"	30	Steel	ALM, BC, DBAC, PB, PC, SN, WH	\$1.86
A271-3.5AL	3-1/2"	3-13/16"	30	Aluminum	AL	\$1.93
K271-3.5-SS	3-1/2"	3-13/16"	30	Stainless Steel	SS	\$4.97
S271-3.5	3-1/2"	3-13/16"	30	Steel	BC, DBAC, PB, PC, SN	\$2.75
A271-96AL	96 mm (3-3/4") CC	4-1/16"	30	Aluminum	AL	\$2.01
K271-96-SS	96 mm (3-3/4") CC	4-1/16"	30	Stainless Steel	SS	\$5.15
S271-96	96 mm (3-3/4") CC	4-1/16"	30	Steel	ALM, BC, DBAC, PB, PC, SN, WH	\$2.01
A271-4AL	4" CC	4-5/16"	30	Aluminum	AL	\$2.07
K271-4SS	4" CC	4-5/16"	30	Stainless Steel	SS	\$6.10
S271-4	4" CC	4-5/16"	30	Steel	BC, DBAC, PB, PC, SN	\$2.95
S271-128	128 mm (5-1/16") CC	5-3/8"	20	Steel	BC, DBAC, PB, PC, SN	\$2.95



Verona

AB Brushed Antique Brass
BLK/MB Matte Black
MS Matte Silver
SN Satin Nickel

Item	Description	Overall Length or Diameter	Ctn Qty	Finishes	List (each)
413322*	knob	1-9/16"	100	MB	\$2.75
409222*	knob	1-9/16"	100	MS, SN	\$2.75
Z105	3" CC	3-7/8"	50	MB, SN	\$3.45
4655	128 mm (5-1/16") CC	6-1/4"	25	AB, BLK, SN	\$5.90
346564	128 mm (5-1/16") CC	6"	30	MB, SN	\$7.01
4307305	192 mm (7-9/16") CC	8-5/8"	20	MB	\$9.68
413321*	128 mm (5-1/16") CC	7-3/8"	20	MB	\$8.95
409223*	128 mm (5-1/16") CC	7-3/8"	20	MS, SN	\$8.95
7210	3" CC cup pull	5-3/4"	50	MB	\$4.83
R1011**	3" CC pull & backplate	3-13/16"	15	MB	\$8.25
R1012**	2-1/4" CC vertical pull & backplate	3-13/16"	25	MB	\$5.45

*M4 attachment screws included with this collection

**Attachment screws not included



Vienna

Item	Description	Overall Length or Diameter	Ctn Qty	Finishes	List (each)
110	knob	1-1/4"	30	DBAC, SN	\$3.30
202	knob	1-1/4"	50	DBAC, SN	\$2.38
110-3	3" CC	5-1/2"	25	DBAC, SN	\$4.91
P106	3" CC	5"	50	DBAC, SN	\$3.71

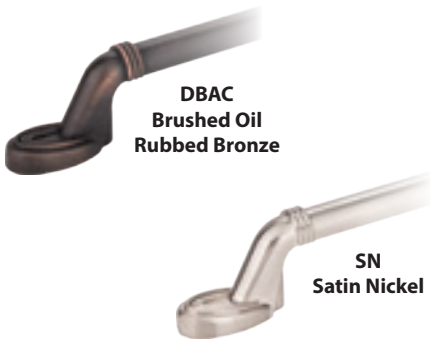



Watervale

Item	Description	Overall Length or Diameter	Ctn Qty	Finishes	List (each)
647	knob	1-1/8"	20	BNBDL, DBAC, PC, SN	\$3.11
647-3	3" CC	4-5/8"	15	BNBDL, DBAC, PC, SN	\$3.86
647-96	96 mm (3-3/4") CC	5-3/8"	20	BNBDL, DBAC, PC, SN	\$5.59

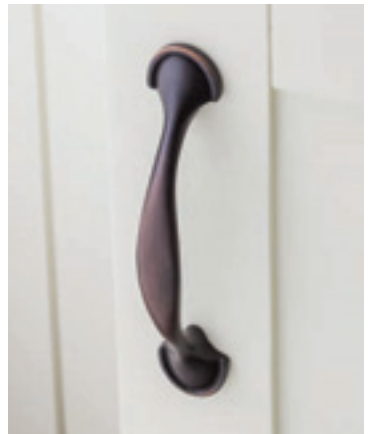



Westbury

Item	Description	Overall Length or Diameter	Ctn Qty	Finishes	List (each)
3898	knob	1-1/4"	20	BNBDL, DBAC, PC, SN	\$4.83
3899	3" CC	5-1/8"	25	BNBDL, DBAC, PC, SN	\$3.83





Zachary

Item	Description	Overall Length or Diameter	Ctn Qty	Finishes	List (each)
988	knob	1-1/16"	25	BNBDL, DBAC, PC, SN	\$3.26
988-3	3" CC	3-3/4"	20	BNBDL, DBAC, PC, SN	\$4.33
988-96	96 mm (3-3/4") CC	4-1/2"	20	BNBDL, DBAC, PC, SN	\$5.99
988-128	128 mm (5-1/16") CC	5-3/4"	25	BNBDL, DBAC, PC, SN	\$7.01
988-160	160 mm (6-5/16") CC	7-1/16"	10	BNBDL, DBAC, PC, SN	\$8.63

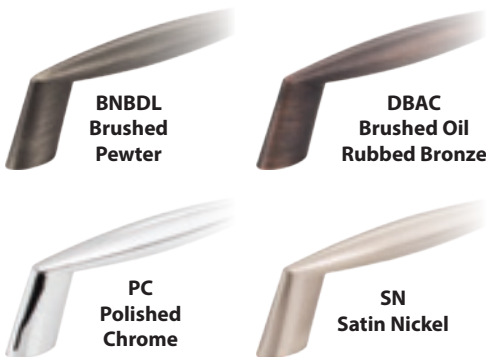

Display Towers

360° revolving towers

36 Board Tower is our most popular display

18 Board Compact Tower

3 Jeffrey Alexander® headers included

Elements® headers also available

24" base footprint

Contemporary design

Over 100 collections

75 collections and 1700 products in the Jeffrey Alexander brand

40 collections and 700 products in the Elements brand

Decorative Hardware Boards can be displayed on a 36-Board tower, an 18-Board tower, or wall/slat wall mounted

Ask about the most popular collections in your area



36 Board Tower
Part number DISPLAY-36
34-15/16" x 30-1/4" x 80-7/8"

18 Board Tower
Part number DISPLAY-18
24" x 24" x 80-7/8"

Item	Description
DISPLAY-36	36-board tower with Jeffrey Alexander headers
DISPLAY-18	18-board tower with Jeffrey Alexander headers
D-36-HEAD-ELE	Elements header for DISPLAY-36
D-18-HEAD-ELE	Elements header for DISPLAY-18

Display Boards



Designer Grey display boards

- Stylish design
- Multiple finishes displayed
- Black edge on grey
- Attractive metal logo
- Price code on each piece

Quickly select decorative hardware

The price code on our Designer Grey display boards under each piece, and a price code key on the tower edge or wall, make it fast and simple for your staff and your customer know the approximate price at a glance.

- Price code key available in a sticker for the tower (part number DISPLAY-KEY17) or as a printable PDF for framing.
- Prices on the printable price code key can be modified by you for your market
- Change prices each year by changing the price code key, not the display board

Label	Price Range
[A]	~ Under \$3
[B]	~\$3 – \$4
[C]	~\$4 – \$5
[D]	~\$5 – \$7
[E]	~\$7 – \$9
[F]	~\$9 – \$12
[G]	~\$12 – \$15
[H]	~\$15 – \$20
[J]	~\$20 – \$25
[K]	See Sales Associate

Part number DISPLAY-KEY17



Price codes are only on Designer Grey boards

Index

Part Number.....	Page	Part Number.....	Page	Part Number.....	Page
26.....	107	239-96.....	84	397.....	103
39.....	103	239-128.....	84	399.....	102
40.....	102	239-160.....	84	400.....	107
48.....	39	239-192.....	84	406-128.....	83
107.....	81	242.....	39	415.....	45
110.....	115	0251.....	24	415-12.....	45
110-3.....	115	254-3.....	97	415-96.....	45
112.....	55	254-96.....	97	415-96V.....	45
112-96.....	55	259.....	43	415-128.....	45
117.....	18	259-96.....	43	415-160.....	45
123.....	31	259-128.....	43	415S.....	45
123-96.....	31	259-160.....	43	417.....	41
125.....	31	259-192.....	43	423.....	89
125-96.....	31	264-3.....	6	423-3.....	89
127.....	20	264-96.....	6	423-96.....	89
0128.....	78	264-128.....	6	424.....	89
136.....	102	264-160.....	6	431.....	63, 65
137.....	20	264-192.....	6	435.....	8
0138.....	78	270.....	103	435-96.....	8
146.....	39	272.....	102	435-128.....	8
0148.....	78	274.....	39	435-160.....	8
152.....	39	286-96.....	44	435L.....	8
154.....	103	286-128.....	44	436-96.....	8
155.....	62	286-160.....	44	436-128.....	8
155-96.....	62	286-192.....	44	449.....	95
155-128.....	62	286-224.....	44	449-3.....	95
156.....	102	293-96.....	74	449-96.....	95
0158.....	78	293-128.....	74	457.....	64
165.....	30	293-160.....	74	457-96.....	64
165-12.....	30	293-192.....	74	457L.....	64
165-96.....	30	293-224.....	74	475.....	107
165-128.....	30	293-305.....	74	484.....	29
165-160.....	30	293T.....	74	484-32.....	29
174.....	103	302.....	103	484-305.....	29
176.....	102	304.....	102	484-396.....	29
177-128.....	16	308-128.....	83	484-128160.....	29
177-160.....	16	317.....	41	484-192224.....	29
177-192.....	16	317-12.....	41	494.....	103
177-224.....	16	317-96.....	41	496.....	102
178.....	39, 78	317-128.....	41	511.....	106
183.....	105	317-160.....	41	511-3.....	106
183-3.....	105	323.....	100	511-96.....	106
183-96.....	105	323-96.....	100	516.....	81
188.....	37	331.....	85	519.....	25
188-96.....	37	331-96.....	85	519-12.....	25
188-128.....	37	331-128.....	85	519-18.....	25
188-160.....	37	331L.....	85	519-96.....	25
188L.....	37	334.....	103	519-128.....	25
193-3.....	82	336.....	102	519-160.....	25
193-4.....	82	343.....	28	525.....	94, 96
193-96.....	82	343-12.....	28	525-96.....	94
193-128.....	82	343-96.....	28	527.....	18
193-160.....	82	343-128.....	28	527-12.....	18
202.....	98, 115	343-160.....	28	527-128.....	18
204.....	103	351.....	85	527-160.....	18
206.....	102	351-96.....	85	530.....	39
211.....	56	351-128.....	85	531.....	40
212-96.....	56	351L.....	85	531-96.....	40
218.....	41	366.....	103	535.....	5
220.....	102	368.....	102	535-96.....	5
225.....	48	370.....	39	535-128.....	5
225-96.....	48	382.....	87	535-160.....	5
225-128.....	48	382-96.....	87	535L.....	5
225-160.....	48	382-128.....	87	536-96.....	5
239.....	84	382-160.....	87	536-128.....	5

Index

Part Number.....Page	Part Number.....Page	Part Number.....Page
537.....20	658-224.....70	867-320.....9
537-12.....20	667.....58	867L.....9
537-128.....20	667-3.....58	874.....17
537-160.....20	667-12.....58	874-96.....17
549-96.....49	667-18.....58	874-128.....17
549-128.....49	667-96.....58	874-160.....17
549-160.....49	667-128.....58	875.....98
549-192.....49	667-160.....58	878.....98
549-320.....49	667-224.....58	885.....35
558.....103	667-305.....58	885-96.....35
560.....102	667L.....58	885-128.....35
575.....112	667S.....58	885-160.....35
575-96.....112	718.....33	885-192.....35
585.....26	718-128.....33	885-224.....35
585-12.....26	719.....103	885-305.....35
585-96.....26	720.....102	885L.....35
585-128.....26	722.....39	897.....104
585-160.....26	737-12.....23	897-3.....104
585L.....26	737-96.....23	897L.....104
595.....21, 63	737-128.....23	910.....53
595-96.....21	737-160.....23	910-12.....53
595-128.....21	745-128.....83	910-96.....53
596.....38	749.....71	910-128.....53
600.....107	749-96B.....71	910-160.....53
602.....69	749-128.....71	910S.....53
602-12.....69	749-128B.....71	915.....23
602-96.....69	749-160.....71	918.....57
602-128.....69	749-224.....71	918-12.....57
602S.....69	752.....66	918-96.....57
613.....7	752-19.....66	918-128.....57
613-96.....7	752-96.....66	918-160.....57
613-128.....7	752-128.....66	918L.....57
613-160.....7	752-160.....66	925.....32
613L.....7	752-192.....66	925-96.....32
618.....33	752-224.....66	935.....54
618L.....33	761.....103	935-12.....54
622.....103	763.....102	935-96.....54
624.....102	771-3.....111	935-128.....54
625-3.....110	771-96.....111	935-160.....54
625-96.....110	771-128.....111	937-3.....96
625-128.....110	771-160.....111	937-96.....96
625-160.....110	776-128.....83	950.....39
625-192.....110	798-96.....63	959.....14
625-224.....110	798-128.....63	959-96.....14
625-320.....110	798-160.....63	972.....47
625-448.....110	818.....13	972-12.....47
635-32.....67	818-12.....13	972-96.....47
635-96.....67	818-96.....13	972-128.....47
635-128.....67	818-128.....13	972-160.....47
635-160.....67	818-160.....13	972-224.....47
635-256.....67	818L.....13	972-305.....47
647.....116	839-3.....22	972L.....47
647-3.....116	839-96.....22	972S.....47
647-96.....116	839-128.....22	976-128.....83
650.....36	839-160.....22	984-3.....108
650-12.....36	840.....98	984-96.....108
650-96.....36	847-96.....59	984-128.....108
650-128.....36	847-128.....59	984-160.....108
650-160.....36	847-160.....59	984-192.....108
658.....70	867.....9	988.....118
658-12.....70	867-3.....9	988-3.....118
658-96.....70	867-96.....9	988-96.....118
658-128.....70	867-128.....9	988-128.....118
658-160.....70	867-160.....9	988-160.....118
658-192.....70	867-228.....9	993.....80

Index

Part Number.....	Page	Part Number.....	Page	Part Number.....	Page
993-3.....	80	81021.....	52	PE08.....	76
993-96.....	16, 80	81065.....	109	R1011.....	114
993-128.....	80	346564.....	114	R1012.....	114
1018.....	98	409222.....	114	S271-3.....	113
1091.....	50	409223.....	114	S271-3.5.....	113
1092.....	50	411689.....	86	S271-4.....	113
1092-12.....	50	412461.....	86	S271-96.....	113
1092-128.....	50	413321.....	114	S271-128.....	113
1092-160.....	50	413322.....	114	S802.....	93
1093.....	51	417572.....	86	S6060.....	61
1094.....	51	530142.....	86	WB150.....	98
1094-12.....	51	530143.....	86	WK150.....	98
1094-128.....	51	530144.....	86	WP150.....	98
1094-160.....	51	4307305.....	114	Z105.....	114
1095.....	73	A271-3.5AL.....	113	Z110.....	23, 24
1096.....	73	A271-3AL.....	113	Z111.....	24
1097.....	60	A271-4AL.....	113	Z115.....	99
1098.....	60	A271-96AL.....	113	Z115-96.....	99
1099.....	60	A500-3.....	90	Z115-128.....	99
1976.....	68	A500-4.....	90	Z115L.....	99
1977.....	68	A500-6.....	90	Z117.....	42
1977S.....	68	A500-8.....	90	Z118.....	88
2980.....	91	A500-10.....	90	Z118-3.....	88
2981.....	91	A500-12.....	90	Z118-96.....	88
3108.....	92	A500-12S.....	90	Z205.....	86
3208.....	92, 98	B812.....	77	Z259-3.....	101
3211.....	86	B812-96.....	77	Z259-12.....	101
3308.....	92	B812-96R.....	61, 77	Z260-3.....	61
3898.....	117	CH3503.....	98	Z260-12.....	61
3899.....	117	CL101.....	78	Z261-96.....	61
3910.....	101	G110.....	34	Z261-128.....	61
3915.....	93, 108	G110L.....	34	Z280.....	24
3940.....	92	G120.....	34	Z281.....	24
3950.....	92	G120L.....	34	Z281-12.....	24
3960.....	92	G130.....	34	Z281-18.....	24
3970.....	92, 97	G130L.....	34	Z281-128.....	24
3980.....	27	G140.....	34	Z281-160.....	24
3990.....	15	G140L.....	34	Z290-3.....	27
3991.....	46	G150.....	34	Z290-12.....	27
4128.....	65	G150L.....	34	Z290-96.....	27
4160.....	65	I300.....	75	Z290-128.....	27
4192.....	65	I350.....	75	Z290-160.....	27
4288.....	65	I350-128.....	75	Z500-128.....	86
4655.....	98, 114	I350-160.....	75	Z718-12.....	33
4656.....	86	K271-3.5-SS.....	113	Z6001.....	93
4690.....	86	K271-3SS.....	113		
5128.....	38	K271-4SS.....	113		
5192.....	38	K271-96-SS.....	113		
5224.....	38	MO6203.....	12		
5319.....	38	MO6273.....	12		
5480.....	38	MO6303.....	10		
5673.....	38	MO6313.....	12		
5900.....	38	MO6373.....	10		
7210.....	114	MO6373-12.....	10		
8004.....	109	MO6373-18.....	10		
8233.....	46	MO6373-128.....	10		
8236.....	15	MO6373-160.....	10		
8237.....	42	P106.....	115		
80152-96.....	52	PE01.....	76		
80152-128.....	52	PE02.....	76		
80152-160.....	52	PE03.....	76		
80508.....	72	PE04.....	76		
80509.....	72	PE05.....	76		
80814.....	109	PE06.....	76		
80815.....	109	PE07.....	76		

hardware **resources**[®]

www.HardwareResources.com



Connect with us on Social Media:

