

Sample Order / Cheat Sheet
N Window Hardware 1/2

QUOTE ORDER

NAME: _____
 ADDRESS: _____

 OFFICE PHONE: _____
 FAX PHONE: _____
 JOB PHONE: _____

PO# _____
 DELIVERY: _____
 ADDRESS: _____



HARDWARE WORK ORDER
 Toll Free 888.788.2013 or 208.788.2013; Fax 208.788.2577

ORDER DATE: _____
 CONTACT: _____
 JOB NAME: _____

301012

LINE NO.	FUNCTION	HANDLE		ESCUTCHEON		METAL	PATINA	HANDING OR LENGTH	BACKSET	DOOR THICKNESS	LOCK TYPE	DEAD BOLT TRIM	DESCRIPTION	LOCATION #	QTY.	PRICE QUOTED
		EXTERIOR	INTERIOR	EXTERIOR	INTERIOR											
1	WN	LW40		EW105		B	D	R		214					1	169.00
2	AC					B	L	R					WC200		1	150.00
3	AC					W	L						WC100		1	141.00
4	LC	LC300				W	D	R					LC305		1	249.00
5	AC					B	M						SL100		1	90.00

FUNCTION

AC = Accessory
 CA = Casement Adjuster
 LC = Casement Latch
 WN = Window Trim Set

HANDLE

For a list of Levers available for Window Hardware, see next page.
For specifications, refer to Section A.

ESCUTCHEONS

For a list of Escutcheons available for Window Hardware, see next page.
For configurations, specifications, and pricing, refer to content of this section.

METAL

B = Silicon Bronze
 W = White Bronze

PATINA

L = Light
 M = Medium
 D = Dark
 R = Rust
 BB = Brushed

HANDING / LENGTH

See Hinged Door Handing diagram, next page.

L = Left Hand
 R = Right Hand
 LR = Left Hand Reverse
 RR = Right Hand Reverse

Casement Adjuster lengths:
 10"
 12"
 14"
 20"

BACKSET

Not Applicable

DOOR THICKNESS

138 = 1 3/8"
 112 = 1 1/2"
 134 = 1 3/4"
 178 = 1 7/8"
 2 = 2"
 214 = 2 1/4"
 212 = 2 1/2"
 258 = 2 5/8"
 234 = 2 3/4"
 3 = 3"

Up-charge for sizes below.
Call for pricing.
 314 = 3 1/4"
 312 = 3 1/2"
 4 = 4"
 N = No

LOCK TYPE

Not Applicable

DEAD BOLT TRIM

Not Applicable

DESCRIPTION

For a list of available descriptions, see next page.

LOCATION #

QTY

Number of each desired

PRICE

\$ List price each

HANDLES

- LW05 = Mini Ellis Lever
- LW10 = Mini Euro Lever
- LW20 = Mini French Lever
- LW33 = Mini Reed Lever
- LW37 = Mini Strap Lever
- LW40 = Mini Classic Lever
- LW50 = Mini Acanthus Lever
- LW60 = Mini Harrington Lever
- LW63 = Mini Olympus Lever
- LW80 = Mini Monarch Lever
- L104 = Hook Lever
- T300 = T Handle
- LC300 = Casement Latch Lever

ESCUTCHEONS

Rectangular

- EW101 = 1 1/4" x 3" Rect (WE)
- EW103 = 1 3/8" x 4 1/2" Rect (WE)
- EW105 = 1 1/2" x 3" Rect (WE)
- EW108 = 1 1/2" x 4 1/2" Rect (WE)

Stepped

- EW308 = 1 1/2" x 4 1/2" Stepped (WE)

Metro

- EW225 = 1 1/4" x 4 1/2" Metro (WE)
- EW202 = 1 1/2" x 4 1/2" Metro (WE)

Curved

- EW507 = 1 1/4" x 4 1/2" Curved (WE)
- EW501 = 1 3/8" x 4 1/2" Curved (WE)
- EW508 = 1 1/2" x 4 1/2" Curved (WE)

Arched

- EW720 = 1 3/16" x 3 3/4" Arched (WE)
- EW707 = 1 3/8" x 4 1/2" Arched (WE)
- EW705 = 1 1/2" x 3" Arched (WE)
- EW708 = 1 1/2" x 4 1/2" Arched (WE)

Ellis

- EW005 = 1 1/2" x 4 1/2" Ellis (WE)

Key

- (WE) = Window Escutcheon

DESCRIPTION

- LC303 = Mortise Strike
- LC305 = Universal Strike
- LC307 = Surface Strike
- SFP100 = Sash Lift
- SL100 = Sash Lock
- DHSL100 = Double-Hung Sash Lock
- DHSL200 = Double-Hung Sash Lock
- DHSL700 = Double-Hung Sash Lock
- ULL200 = Sash Lock (Pella)
- LC420 = Sash Lock (Marvin)
- LC500 = Sash Lock (Loewen)
- LC510 = Sash Lock (Truth)
- LC600 = Sash Lock (Truth)
- LC730 = Sash Lock (Sierra Pacific)
- LC710 = Tilt Lock (Sierra Pacific)
- WC100 = Truth Window Crank & Cover
- WC104 = Truth Window Cover Only
- WC108 = Truth Window Crank Only
- WC160 = Truth Window Crank & Cover
- WC150 = Truth Window Cover Only
- WC110 = Truth Window Crank Only
- WC200 = Pella Window Crank & Cover
- WC204 = Pella Window Cover Only
- WC208 = Pella Window Crank Only
- WC400 = Marvin Window Crank & Cover
- WC404 = Marvin Window Cover Only
- WC408 = Marvin Window Crank Only
- WC450 = Truth Window Crank & Cover
- WC451 = Truth Window Cover Only
- WC452 = Truth Window Crank Only

HANDING

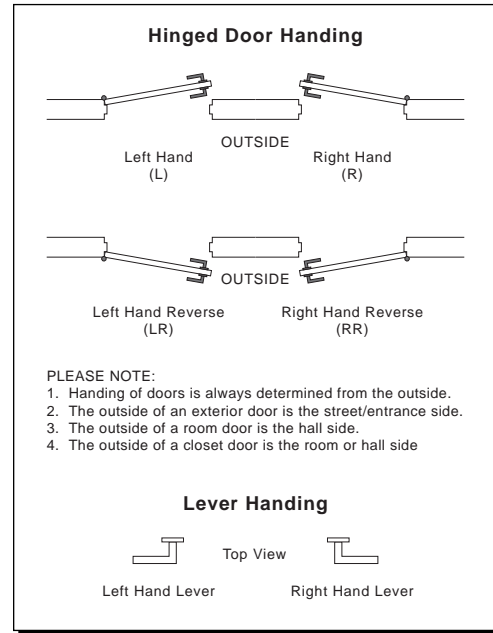

- All finishes are priced the same.
- Price includes your choice of any lever. Call for pricing.
- Combinations are shown with L104 Hook Lever for illustrations only. Refer to Section A for desired lever.
- Specify metal, patina, sash thickness, handing, screws, spindle length, and type of window designed for.
- Supplied with M5 x .8 x 40 mm screws and 7 mm spindle unless otherwise specified.
- Levers index at 3, 6, 9, and 12 o'clock positions.

Window Trim Sets

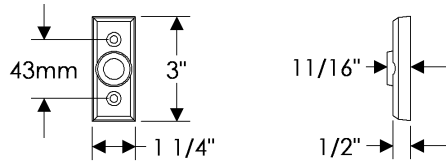

EW101 Rectangular Window Escutcheon
1 1/4" x 3" \$ 285.00

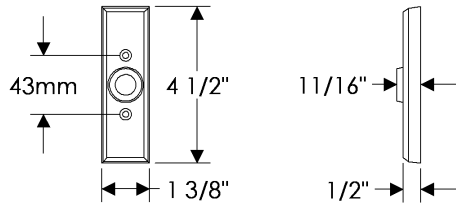

EW103 Rectangular Window Escutcheon
1 3/8" x 4 1/2" \$ 285.00

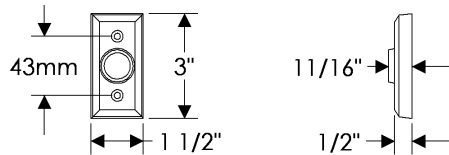

EW105 Rectangular Window Escutcheon
1 1/2" x 3" \$ 169.00

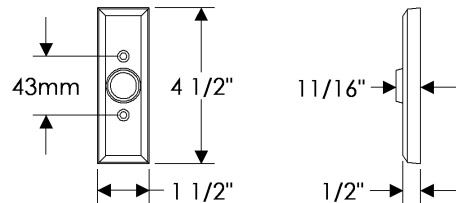

EW108 Rectangular Window Escutcheon
1 1/2" x 4 1/2" \$ 178.00

- All finishes are priced the same.
- Price includes your choice of any lever. Call for pricing.
- Combinations are shown with L104 Hook Lever for illustrations only. Refer to Section A for desired lever.
- Specify metal, patina, sash thickness, handing, screws, spindle length, and type of window designed for.
- Supplied with M5 x .8 x 40 mm screws and 7 mm spindle unless otherwise specified.
- Levers index at 3, 6, 9, and 12 o'clock positions.

Window Trim Sets

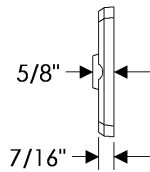
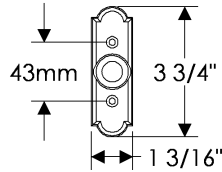

EW720 Arched Window Escutcheon
 1 3/16" x 3 3/4" \$ 285.00

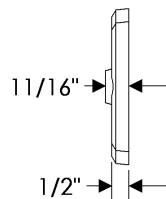
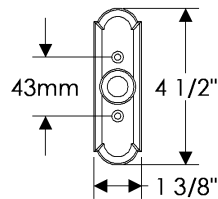

EW707 Arched Window Escutcheon
 1 3/8" x 4 1/2" \$ 285.00

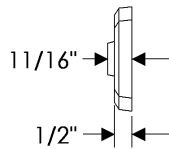
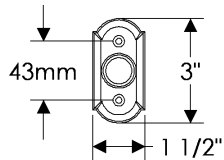

EW705 Arched Window Escutcheon
 1 1/2" x 3" \$ 169.00

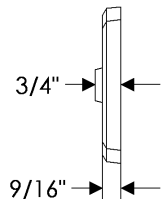
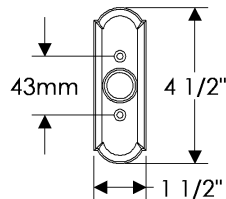

EW708 Arched Window Escutcheon
 1 1/2" x 4 1/2" \$ 178.00

- All finishes are priced the same.
- Price includes your choice of any lever. Call for pricing.
- Combinations are shown with L104 Hook Lever for illustrations only. Refer to Section A for desired lever.
- Specify metal, patina, sash thickness, handing, screws, spindle length, and type of window designed for.
- Supplied with M5 x .8 x 40 mm screws and 7 mm spindle unless otherwise specified.
- Levers index at 3, 6, 9, and 12 o'clock positions.

Window Trim Sets

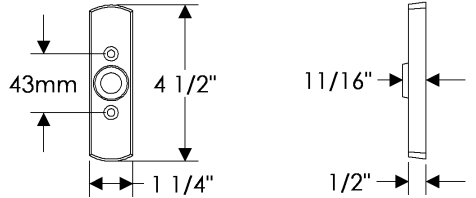

EW507 Curved Window Escutcheon
 1 1/4" x 4 1/2" \$ 285.00

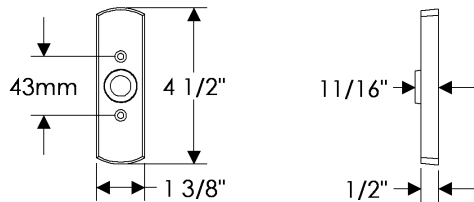

EW501 Curved Window Escutcheon
 1 3/8" x 4 1/2" \$ 285.00

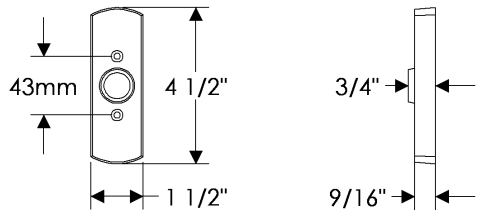

EW508 Curved Window Escutcheon
 1 1/2" x 4 1/2" \$ 178.00

- All finishes are priced the same.
- Price includes your choice of any lever. Call for pricing.
- Combinations are shown with L104 Hook Lever for illustrations only. Refer to Section A for desired lever.
- Specify metal, patina, sash thickness, handing, screws, spindle length, and type of window designed for.
- Supplied with M5 x .8 x 40 mm screws and 7 mm spindle unless otherwise specified.
- Levers index at 3, 6, 9, and 12 o'clock positions.

Window Trim Sets

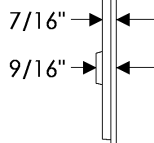
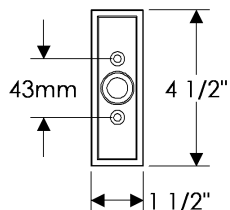

EW308 Stepped Window Escutcheon
 1 1/2" x 4 1/2" \$ 285.00

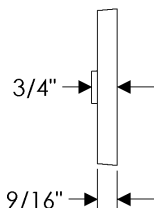
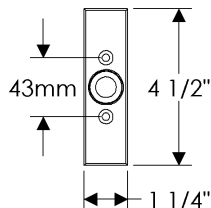

EW225 Metro Window Escutcheon
 1 1/4" x 4 1/2" \$ 285.00

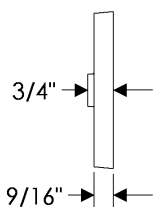
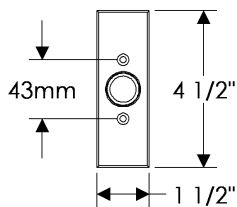

EW202 Metro Window Escutcheon
 1 1/2" x 4 1/2" \$ 178.00

- All finishes are priced the same.
- Price includes your choice of any lever. Call for pricing.
- Combination is shown with LW05 Mini Ellis Lever for illustrations only. Refer to Section A for desired lever.
- Specify metal, patina, sash thickness, handing, screws, spindle length, and type of window designed for.
- Supplied with M5 x .8 x 40 mm screws and 7 mm spindle unless otherwise specified.
- Levers index at 3, 6, 9, and 12 o'clock positions.

Window Trim Sets

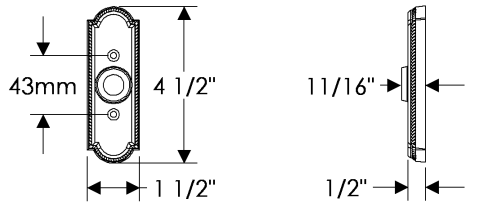

EW005 Ellis Window Escutcheon
 1 1/2" x 4 1/2" \$ 309.00

- All finishes are priced the same.
- Specify metal and patina (and handing for the WC200 and WC160 series).

Window Cranks

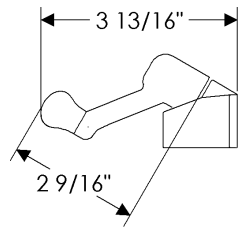
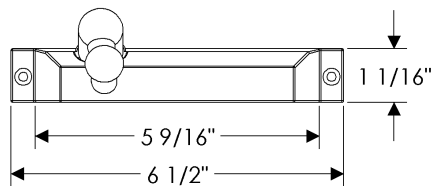
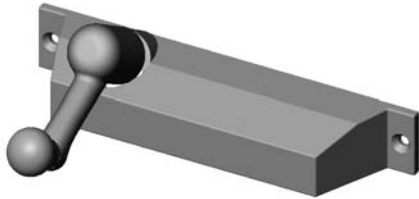

Casement Window Hardware*

WC160 Crank & Cover \$ 150.00
WC150 Cover Only \$ 69.00
WC110 Encore Crank Only \$ 81.00
WC108 Maxim Crank Only \$ 81.00

* Specify Truth Encore or Truth Maxim

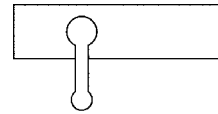

LEFT HAND WINDOW (L)

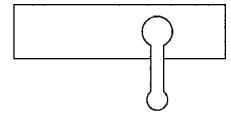

RIGHT HAND WINDOW (R)

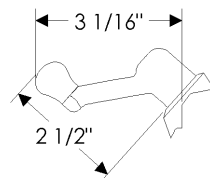
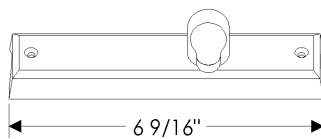
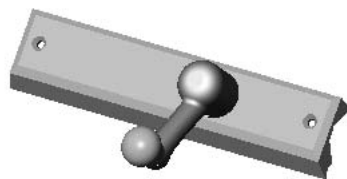

Casement Window Hardware*

WC200 Crank & Cover \$ 150.00
WC204 Cover Only \$ 69.00
WC208 Crank Only \$ 81.00

* Designed for Pella Architect and Designer Series models.

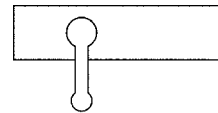

LEFT HAND WINDOW (L)

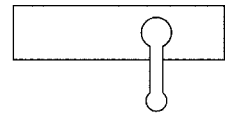

RIGHT HAND WINDOW (R)

- All finishes are priced the same.
- Specify metal and patina (and handing for the WC450 series).

Window Cranks

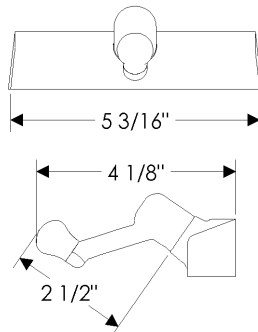
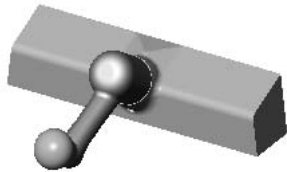

Casement Window Hardware*

WC100 Crank & Cover	\$ 145.00
WC104 Cover Only	\$ 64.00
WC108 Crank Only	\$ 81.00

- * Designed for Truth Entry Guard.
- * Can be modified for compatibility with Ashland Mechanisms. Call for pricing.

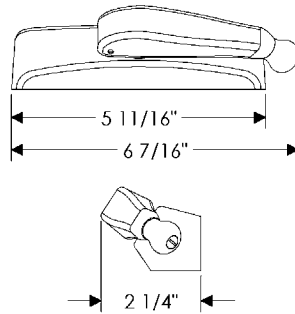

Casement Window Hardware*

WC400 Crank & Cover	\$ 223.00
WC404 Cover Only	\$ 78.00
WC408 Crank Only	\$ 145.00

- * Designed for Truth Entry Guard.
- * Can be modified for compatibility with Ashland Mechanisms. Call for pricing.

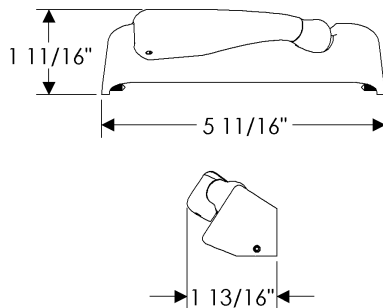
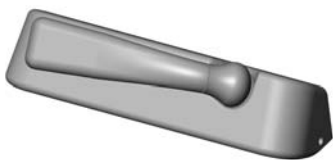

Casement Window Hardware*

WC450 Crank & Cover	\$ 223.00
WC451 Cover Only	\$ 78.00
WC452 Crank Only	\$ 145.00

- * Designed for Truth Encore.
- * For most situations a left hand cover will work with a left hand window. Narrow windows may be an exception. Verify cover handing with images below.

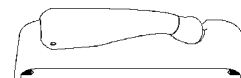

LEFT HAND COVER (L)

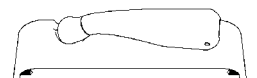

RIGHT HAND COVER (R)

- All finishes are priced the same.
- Specify metal, patina, and handing.

Casement Latches

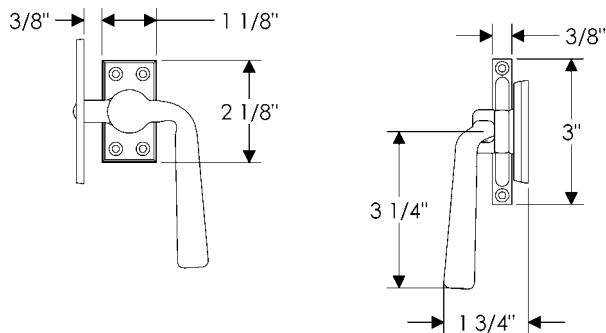

LC300 Casement Latch
with **LC303** Mortise Strike \$ 238.00

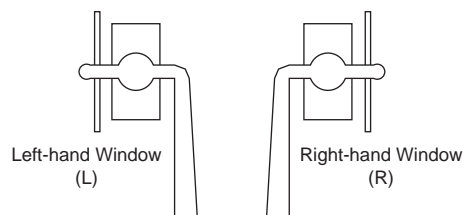

- Optional strike: **LC307**

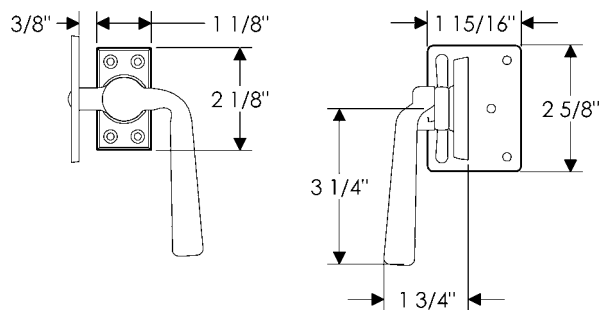
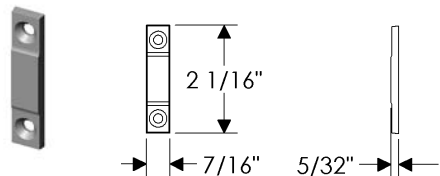

LC300 Casement Latch
with **LC305** Universal Strike \$ 249.00

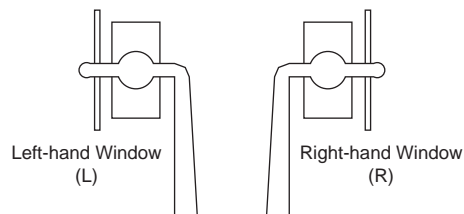

- Optional strike: **LC307**

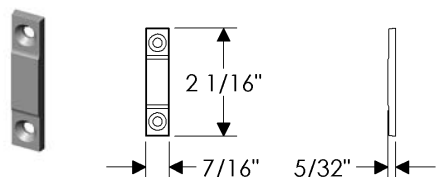

- All finishes are priced the same.
- Specify metal and patina (and handing for the ULL200 Sash Lock).

Sash Lift and Locks

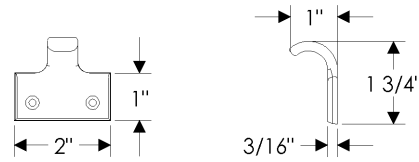

SFP100 Sash Lift \$ 38.00

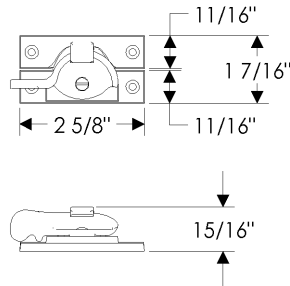

SL100 Sash Lock \$ 90.00

- Optional strike: **SLK105**

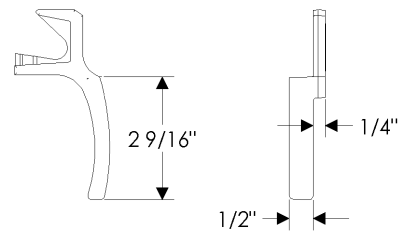
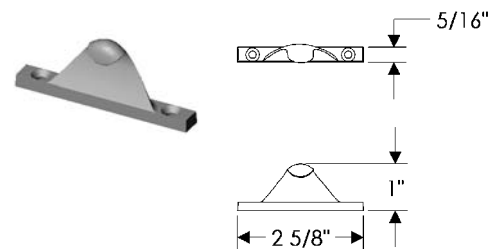

ULL200 Sash Lock* \$ 44.00

- * Designed for Pella windows.
Call for compatibility.

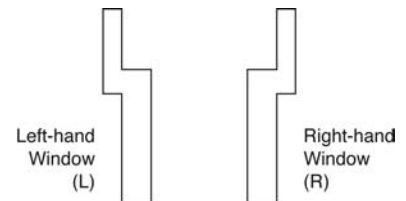

- All finishes are priced the same.
- Specify metal and patina.

Sash Locks



LC730 Sash Lock* \$ 252.00

- * Designed for Sierra Pacific windows.
- * Use in conjunction with WC450.

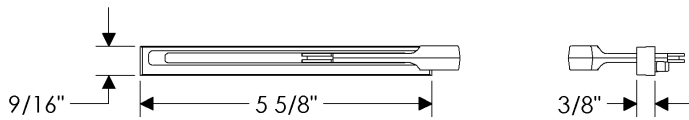

LC420 Sash Lock* \$ 275.00

- * Designed for Marvin Casemaster windows.
Call for compatibility.

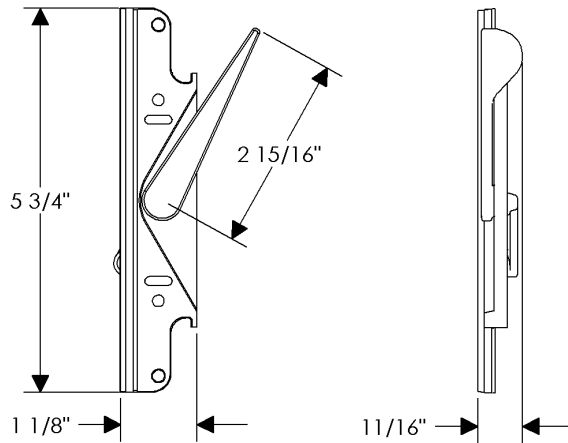

- All finishes are priced the same.
- Specify metal and patina.

Sash Locks

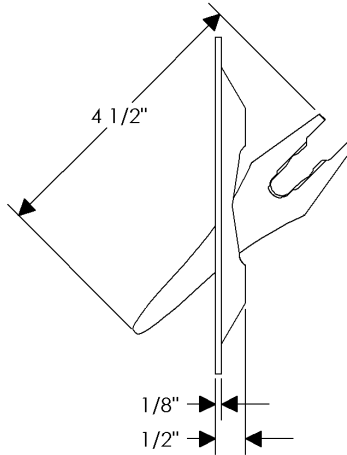
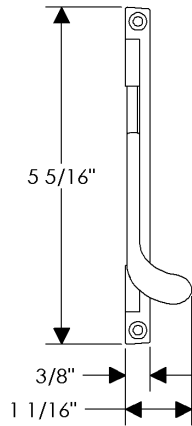

LC500 Sash Lock* \$ 252.00

* Designed for Truth Mirage Concealed Multi-point Locking Systems.

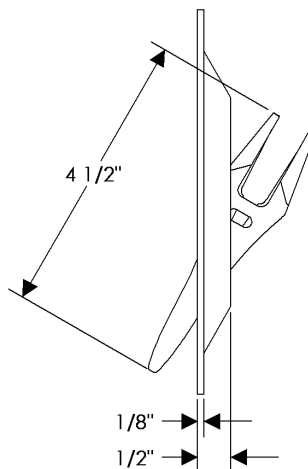
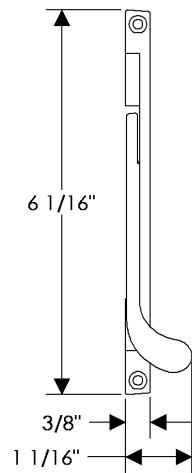

LC510 Sash Lock* \$ 252.00

* Designed for Ashland Multi-point Casement Locks.

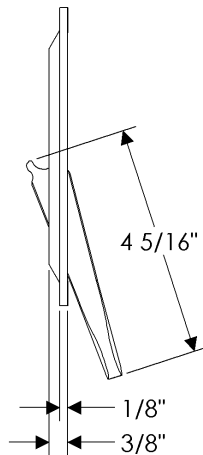
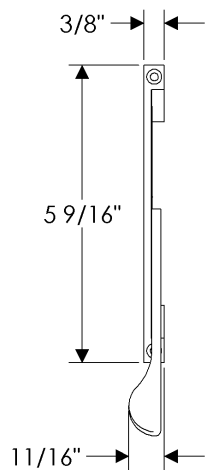

LC600 Sash Lock* \$ 252.00

* Designed for Truth Encore Multi-point Casement Locks.

* Field modifications required, call for specifications.

- All finishes are priced the same.
- Specify metal and patina.

Double-Hung Sash Lock

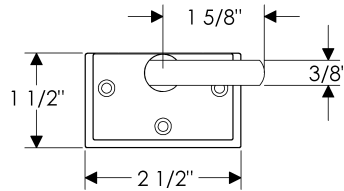
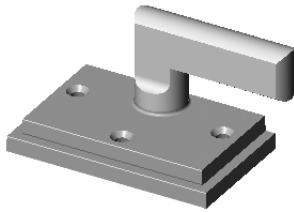

DHSL100 Double-Hung Sash Lock . . \$ 120.00

- Compatible with Pella Model 2 Architect series windows
- Includes strike (not pictured)

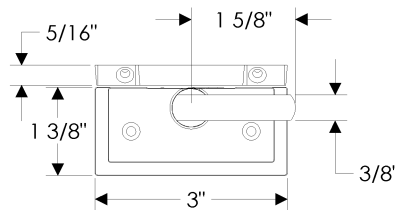
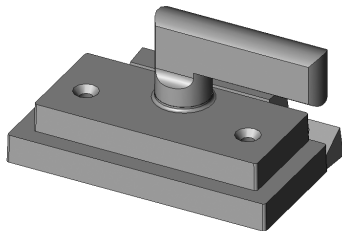
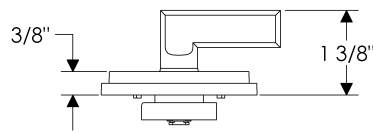

DHSL200 Double-Hung Sash Lock . . \$ 164.00

- Compatible with Pella Model 3 Architect series windows
- Includes bronze strike

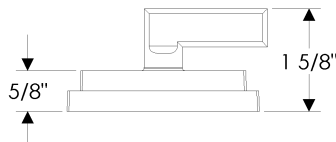

- All finishes are priced the same.
- Specify metal and patina.

Double-Hung Sash Lock

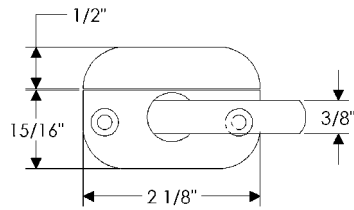

DHSL700 Double-Hung Sash Lock . . . \$ 164.00

- Designed for Sierra Pacific
- Includes bronze strike
- Used in conjunction with LC710 Tilt Lock

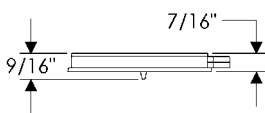
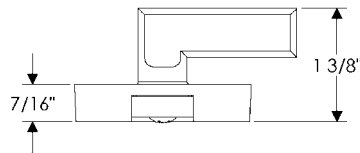

LC710 Tilt Lock \$ 155.00

- Designed for Sierra Pacific
- Used in conjunction with DHSL700 Double Hung Sash Lock

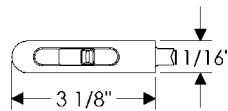

- All finishes are priced the same.
- Specify metal and patina.

Casement Adjusters

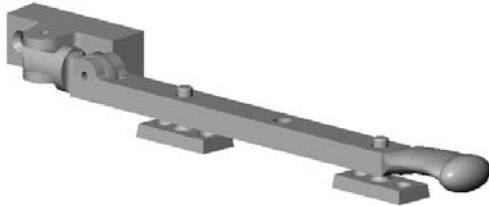

CA10 Casement Adjuster \$ 264.00

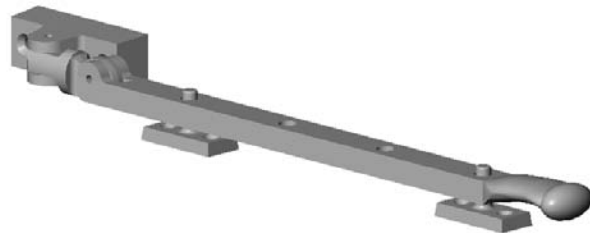
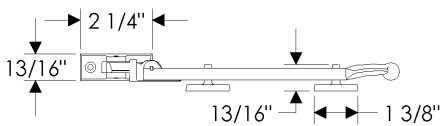
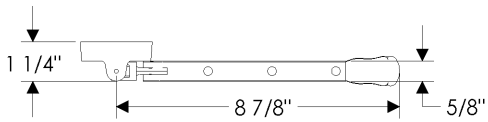

CA12 Casement Adjuster \$ 268.00

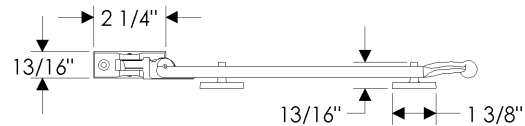
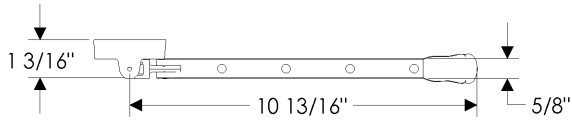

- All finishes are priced the same.
- Specify metal and patina.

Casement Adjusters

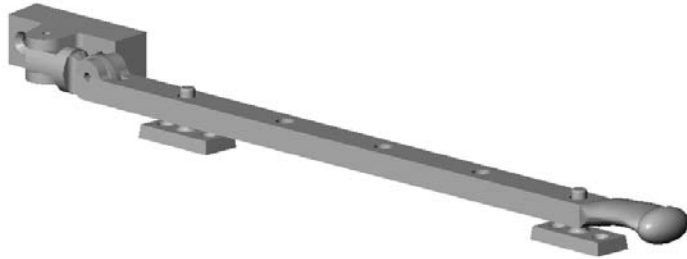

CA14 Casement Adjuster \$ 272.00

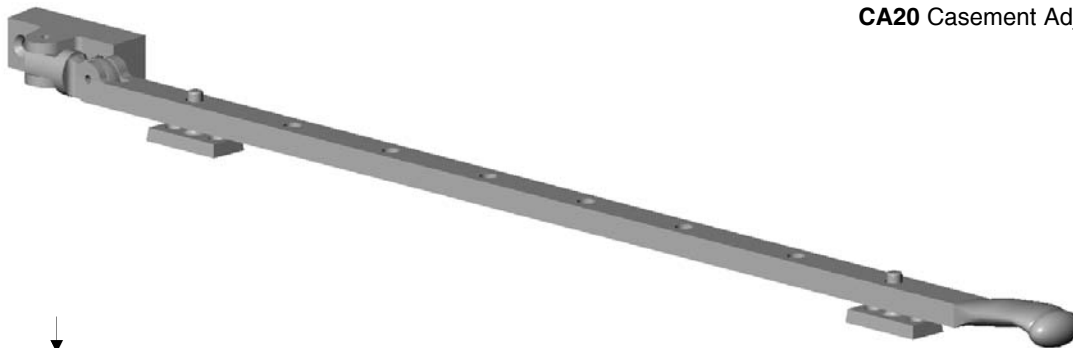
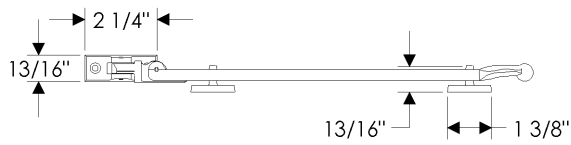
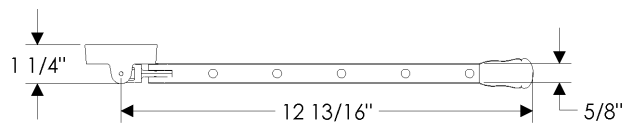

CA20 Casement Adjuster \$ 314.00

