

Sample Order / Cheat Sheet
I Sliding Door Sets 1/3

QUOTE ORDER

NAME: _____

PO# _____

ADDRESS: _____

DELIVERY: _____

ADDRESS: _____



ORDER DATE: _____

OFFICE PHONE: _____

CONTACT: _____

FAX PHONE: _____

JOB NAME: _____

JOB PHONE: _____

HARDWARE WORK ORDER
Toll Free 888.788.2013 or 208.788.2013; Fax 208.788.2577

LINE NO.	FUNCTION	HANDLE		ESCUTCHEON		METAL	PATINA	HANDING OR LENGTH	BACKSET	DOOR THICKNESS	LOCK TYPE	DEAD BOLT TRIM	DESCRIPTION	LOCATION #	QTY.	PRICE QUOTED
		EXTERIOR	INTERIOR	EXTERIOR	INTERIOR											
1	SLPO	SDP6	SDP6	E468	E469	B	L	OX	N	134	AM			26	1	519.00
2	SLEN	L124	L124	E333	E333	W	D	XO	N	134	PR		122mm	30	1	746.00
3	SDL					B	D	D	212	134	PO		FP258		1	913.00
4	PDL					B	M			134			FP210		1	472.00
5	AC					B	M						FP208		2	96.00
6	AC					B	M						EP100		1	66.00
7	AC					W	L						BF100		1	300.00

FUNCTION

AC = Accessory
SLDU = Dummy
PDL = Pocket Door Lock
SDL = Sliding Door Lock
SLEN = Sliding Door Entry
SLPO = Sliding Door Patio

HANDLE

For a list of Grips and Flush Pulls available for Sliding Door Sets and Hardware, see next page.

For specifications, refer to Section A.

ESCUTCHEONS

For a list of Escutcheons available for Sliding Door Sets, see next page.

For configurations, specifications, and pricing, refer to content of this section.

METAL

B = Silicon Bronze
W = White Bronze

PATINA

L = Light
M = Medium
D = Dark
R = Rust
BB = Brushed

HANDING

See Sliding Door Handing diagram, next page.

BACKSET

238 = 2 3/8"
212 = 2 1/2"
234 = 2 3/4"

Up-charge for sizes below.
Call for pricing.

114 = 1 1/4"
112 = 1 1/2"
134 = 1 3/4"
2 = 2"
214 = 2 1/4"
334 = 3 3/4"
5 = 5"
6 = 6"
N = No

DOOR THICKNESS

138 = 1 3/8"
112 = 1 1/2"
134 = 1 3/4"
178 = 1 7/8"
2 = 2"
214 = 2 1/4"

Up-charge for sizes below.
Call for pricing.

212 = 2 1/2"
258 = 2 5/8"
234 = 2 3/4"
3 = 3"
314 = 3 1/4"
312 = 3 1/2"
4 = 4"
N = No

LOCK TYPE

Complete Sets

PO = Patio Function
PR = Privacy Function
EN = Entry Function
AM = American Cylinder
PR = Profile Cylinder

DEAD BOLT TRIM

Not Applicable

DESCRIPTION

Center to Center dimension

Edge Pulls

EP100 = 1" x 4 1/2" Edge Pull

Slide Folds

BF100 = 1 1/8" x 2 3/4"

Flush Pulls

For a list of Flush Pulls available for Sliding Door Sets, see next page.

LOCATION #

Room Number or Door Number, etc.

QTY

Number of each desired

PRICE

\$ List price each

HANDLE

Grips

- G258 = 6" Offset Rail Grip
- G259 = 8 1/16" Offset Curved Rail Grip
- G260 = 6" Offset Curved Rail Grip
- G262 = 24" Offset Curved Rail Grip
- G588 = 10" Offset Maddox Grip
- G645 = 6" Offset Olympus Pull
- G830 = Low-Projection Sliding Door Grip
- G10810 = 6" Offset Briggs Grip
- SDP6 = 6" Offset D Grip
- SDT6 = 6" Offset Branch Grip

Levers

Multi-Point Sliding Door

- L124 = Offset Lever
- L177 = Offset Tube Lever

Lift & Slide

- L114 = Long Hook Lever
- L138 = Long Monarch Lever
- L139 = Long Old World Lever
- L142 = Long Legacy Lever
- L144 = Extra Long Hook Lever
- L145 = Long Olympus Lever
- L146 = Long Triple Twist Lever
- L148 = Long French Lever
- L149 = Long Jane Lever
- L167 = Long Bamboo Lever
- L168 = Long Twig Lever
- L172 = Long Acanthus Lever
- L173 = Long Lariat Lever
- L176 = Long Rock Creek Lever
- L180 = Long Harrington Lever
- L21075= Long Emile Lever

ESCUTCHEONS

Rectangular

- E468 = 1 3/8" x 11" Rect (GCtr)
- E469 = 1 3/8" x 11" Rect (GCtr)(TP)
- E484 = 1 3/8" x 11" Rect (GLo)
- E485 = 1 3/8" x 11" Rect (GLo)(AM)
- E482 = 1 3/8" x 11" Rect (GLo)(TP)
- E456 = 1 3/8" x 11" Rect (Lvr)
- E440 = 1 3/8" x 11" Rect (Lvr)(PR)
- E444 = 1 3/4" x 11" Rect (GCtr)
- E466 = 1 3/4" x 11" Rect (GCtr)(TP)
- E446 = 1 3/4" x 11" Rect (Lvr)
- E449 = 1 3/4" x 11" Rect (Lvr)(PR)
- E446 = 1 3/4" x 11" Rect (LS)
- E496 = 1 3/4" x 13" Rect (GLo)
- E498 = 1 3/4" x 13" Rect (GLo)(AM)
- E497 = 1 3/4" x 13" Rect (GLo)(TP)

Rectangular (continued)

- E490 = 2 1/2" x 13" Rect (GLo)
- E491 = 2 1/2" x 13" Rect (GLo)(TP)
- E493 = 2 1/2" x 13" Rect (GLo)
- E494 = 2 1/2" x 13" Rect (GLo)(TP)

Stepped

- E318 = 1 3/8" x 11" Stepped (GCtr)
- E319 = 1 3/8" x 11" Stepped (GCtr)(TP)
- E320 = 1 3/8" x 11" Stepped (GLo)
- E326 = 1 3/8" x 11" Stepped (GLo)(AM)
- E321 = 1 3/8" x 11" Stepped (GLo)(TP)

- E370 = 1 3/8" x 13" Stepped (GLo)
- E372 = 1 3/8" x 13" Stepped (GLo)(AM)
- E371 = 1 3/8" x 13" Stepped (GLo)(TP)

- E351 = 1 3/4" x 11" Stepped (GCtr)
- E352 = 1 3/4" x 11" Stepped (GCtr)(TP)
- E330 = 1 3/4" x 11" Stepped (Lvr)
- E333 = 1 3/4" x 11" Stepped (Lvr)(PR)
- E330 = 1 3/4" x 11" Stepped (LS)

- E341 = 1 3/4" x 13" Stepped (GLo)
- E343 = 1 3/4" x 13" Stepped (GLo)(AM)
- E342 = 1 3/4" x 13" Stepped (GLo)(TP)

Arched

- E708 = 1 3/8" x 11" Arched (GCtr)
- E709 = 1 3/8" x 11" Arched (GCtr)(TP)
- E715 = 1 3/8" x 11" Arched (GLo)
- E714 = 1 3/8" x 11" Arched (GLo)(AM)
- E717 = 1 3/8" x 11" Arched (GLo)(TP)
- E718 = 1 3/8" x 11" Arched (Lvr)
- E720 = 1 3/8" x 11" Arched (Lvr)(PR)

- E760 = 1 3/4" x 11" Arched (GCtr)
- E762 = 1 3/4" x 11" Arched (GCtr)(TP)
- E746 = 1 3/4" x 11" Arched (Lvr)
- E740 = 1 3/4" x 11" Arched (Lvr)(PR)
- E746 = 1 3/4" x 11" Arched (LS)

- E796 = 1 3/4" x 13" Arched (GLo)
- E798 = 1 3/4" x 13" Arched (GLo)(AM)
- E797 = 1 3/4" x 13" Arched (GLo)(TP)

- E790 = 2 1/2" x 13" Arched (GLo)
- E791 = 2 1/2" x 13" Arched (GLo)(TP)
- E793 = 2 1/2" x 13" Arched (GLo)
- E794 = 2 1/2" x 13" Arched (GLo)(TP)

Curved

- E518 = 1 3/8" x 11" Curved (GCtr)
- E519 = 1 3/8" x 11" Curved (GCtr)(TP)
- E520 = 1 3/8" x 11" Curved (GLo)
- E526 = 1 3/8" x 11" Curved (GLo)(AM)
- E521 = 1 3/8" x 11" Curved (GLo)(TP)

Curved (continued)

- E576 = 1 3/8" x 11" Curved (Lvr)
- E564 = 1 3/8" x 11" Curved (Lvr)(PR)
- E551 = 1 3/4" x 11" Curved (GCtr)
- E552 = 1 3/4" x 11" Curved (GCtr)(TP)
- E530 = 1 3/4" x 11" Curved (Lvr)
- E533 = 1 3/4" x 11" Curved (Lvr)(PR)
- E530 = 1 3/4" x 11" Curved (LS)
- E561 = 1 3/4" x 13" Curved (GLo)
- E563 = 1 3/4" x 13" Curved (GLo)(AM)
- E562 = 1 3/4" x 13" Curved (GLo)(TP)

Briggs

- E10879 = 2" x 15" Briggs (GCtr)
- E10880 = 2" x 15" Briggs (GCtr)(TP)
- E10883 = 2" x 15" Briggs (GLo)
- E10881 = 2" x 15" Briggs (GLo)(AM)
- E10882 = 2" x 15" Briggs (GLo)(TP)
- E10871 = 2" x 15" Briggs (Lvr)
- E10885 = 2" x 15" Briggs (Lvr)(PR)

Maddox

- E598 = 1 3/4" x 11" Maddox (GCtr)
- E599 = 1 3/4" x 11" Maddox (GCtr)(TP)
- E591 = 1 3/4" x 11" Maddox (Lvr)
- E593 = 1 3/4" x 11" Maddox (Lvr)(PR)
- E591 = 1 3/4" x 11" Maddox (LS)

Metro

- E218 = 1 3/8" x 11" Metro (GCtr)
- E219 = 1 3/8" x 11" Metro (GCtr)(TP)
- E220 = 1 3/8" x 11" Metro (GLo)
- E235 = 1 3/8" x 11" Metro (GLo)(AM)
- E234 = 1 3/8" x 11" Metro (GLo)(TP)
- E270 = 1 3/8" x 11" Metro (Lvr)
- E275 = 1 3/8" x 11" Metro (Lvr)(PR)

- E227 = 1 3/4" x 11" Metro (GCtr)
- E228 = 1 3/4" x 11" Metro (GCtr)(TP)
- E221 = 1 3/4" x 11" Metro (GLo)
- E223 = 1 3/4" x 11" Metro (GLo)(AM)
- E222 = 1 3/4" x 11" Metro (GLo)(TP)
- E241 = 1 3/4" x 11" Metro (Lvr)
- E248 = 1 3/4" x 11" Metro (Lvr)(PR)
- E241 = 1 3/4" x 11" Metro (LS)

- E224 = 1 3/4" x 13" Metro (GLo)
- E226 = 1 3/4" x 13" Metro (GLo)(AM)
- E225 = 1 3/4" x 13" Metro (GLo)(TP)

Ellis

- E027 = 1 3/4" x 11" Ellis (GCtr)
- E028 = 1 3/4" x 11" Ellis (GCtr)(TP)
- E021 = 1 3/4" x 11" Ellis (GLo)

Ellis (continued)

- E023 = 1 3/4" x 11" Ellis (GLo)(AM)
- E022 = 1 3/4" x 11" Ellis (GLo)(TP)
- E041 = 1 3/4" x 11" Ellis (Lvr)
- E048 = 1 3/4" x 11" Ellis (Lvr)(PR)
- E041 = 1 3/4" x 11" Ellis (LS)

Mack

- E21027 = 1 3/4" x 13" Mack (GCtr)
- E21028 = 1 3/4" x 13" Mack (GCtr)(TP)
- E21021 = 1 3/4" x 13" Mack (GLo)
- E21023 = 1 3/4" x 13" Mack (GLo)(AM)
- E21022 = 1 3/4" x 13" Mack (GLo)(TP)

- E21041 = 1 3/4" x 11" Mack (Lvr)
- E21048 = 1 3/4" x 11" Mack (Lvr)(PR)
- E21041 = 1 3/4" x 11" Mack (LS)

Flush Pulls

- FP025 = 2 1/2" x 11" Ellis
- FP105 = 2 3/4" x 8" Designer
- FP204 = 2" x 4 1/4" Rect
- FP206 = 2 1/4" x 6" Rect
- FP208 = 2 1/2" x 8" Rect
- FP210 = 2 1/2" x 10" Rect
- FP212 = 1 3/4" x 12" Rect
- FP216 = 1 3/4" x 6" Rect
- FP218 = 2" x 8" Rect
- FP219 = 2 11/16" x 20" Rect
- FP224 = 1 3/8" x 4 5/16" Curved
- FP249 = 2 1/2" x 9" Curved
- FP252 = 2 1/2" x 12" Curved
- FP253 = 2 1/2" x 11" Arched
- FP255 = 2 1/2" x 12 1/4" Arched
- FP256 = 2" x 11" Rect
- FP258 = 2 1/2" x 8 1/2" Rect
- FP259 = 2 1/2" x 9" Arched
- FP262 = 2 1/2" x 13" Rect
- FP268 = 2 1/2" x 10" Rect
- FP269 = 2 1/2" x 9" Arched
- FP270 = 2 1/2" x 11" Arched
- FP308 = 2 1/2" x 8" Rect
- FP512 = 3" x 12 1/2" Maddox
- FP1349= 1 3/4" x 9" Arched

Key

- (AM) = American Cylinder Escutcheon
- (GCtr) = Grip Centered
- (GLo) = Grip Low
- (LS) = Lift & Slide Escutcheon
- (Lvr) = Lever
- (PR) = Profile Cylinder Escutcheon
- (TP) = Turn Piece Escutcheon

HANDING

Sliding Door Handing

The diagrams show four configurations of sliding door sets from an exterior perspective:

- XO:** A single door set with an arrow pointing right, indicating the door slides to the right.
- OXO:** A double door set with an arrow pointing right, indicating the right door slides to the right.
- OX:** A double door set with an arrow pointing left, indicating the left door slides to the left.
- OXXO:** A double door set with an arrow pointing left on the left door and an arrow pointing right on the right door, labeled "Active", indicating the right door is the locking panel and slides to the right.

PLEASE NOTE:

1. All views are shown from the exterior side.
2. Active Panel is the locking panel and its location must be verified.

Patio Sliding Door Set

- 1 Escutcheon
- 2 Grip
- 3 Turn Piece
- 4 Sex Bolt
- 5 Sex Bolt Machine Screw

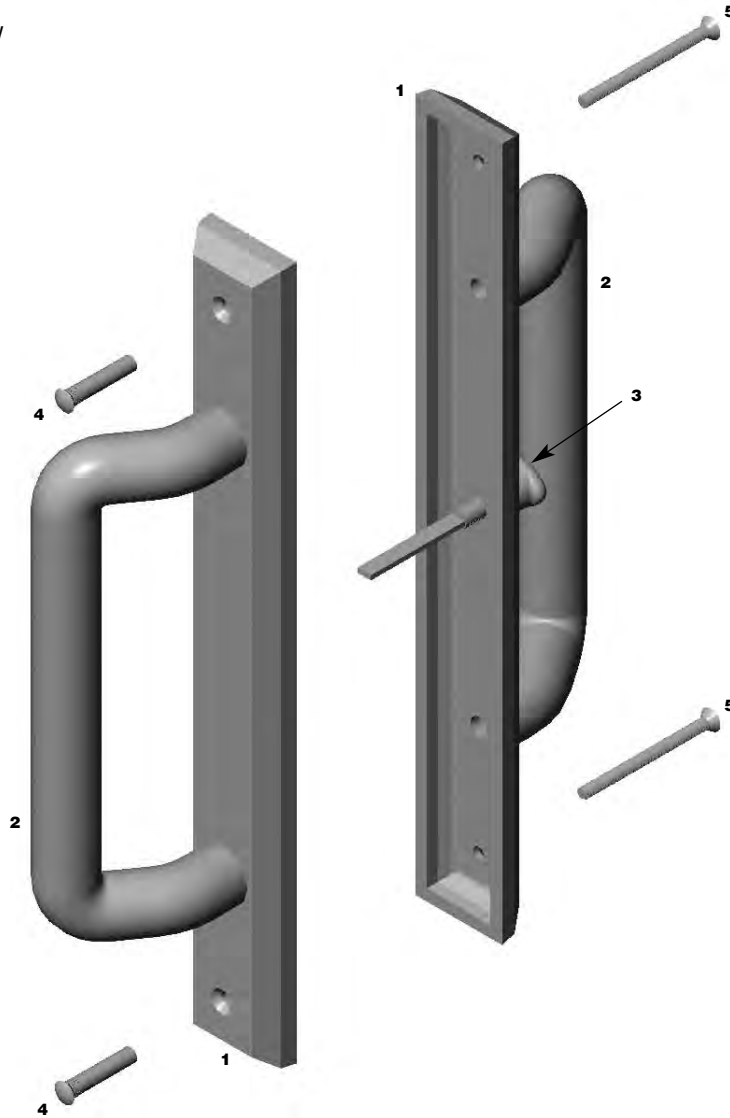

Entry Sliding Door Set

- 1 Escutcheon
- 2 Grip
- 3 Turn Piece
- 4 American Cylinder
- 5 Sex Bolt Machine Screw
- 6 Sex Bolt
- 7 Tail Piece

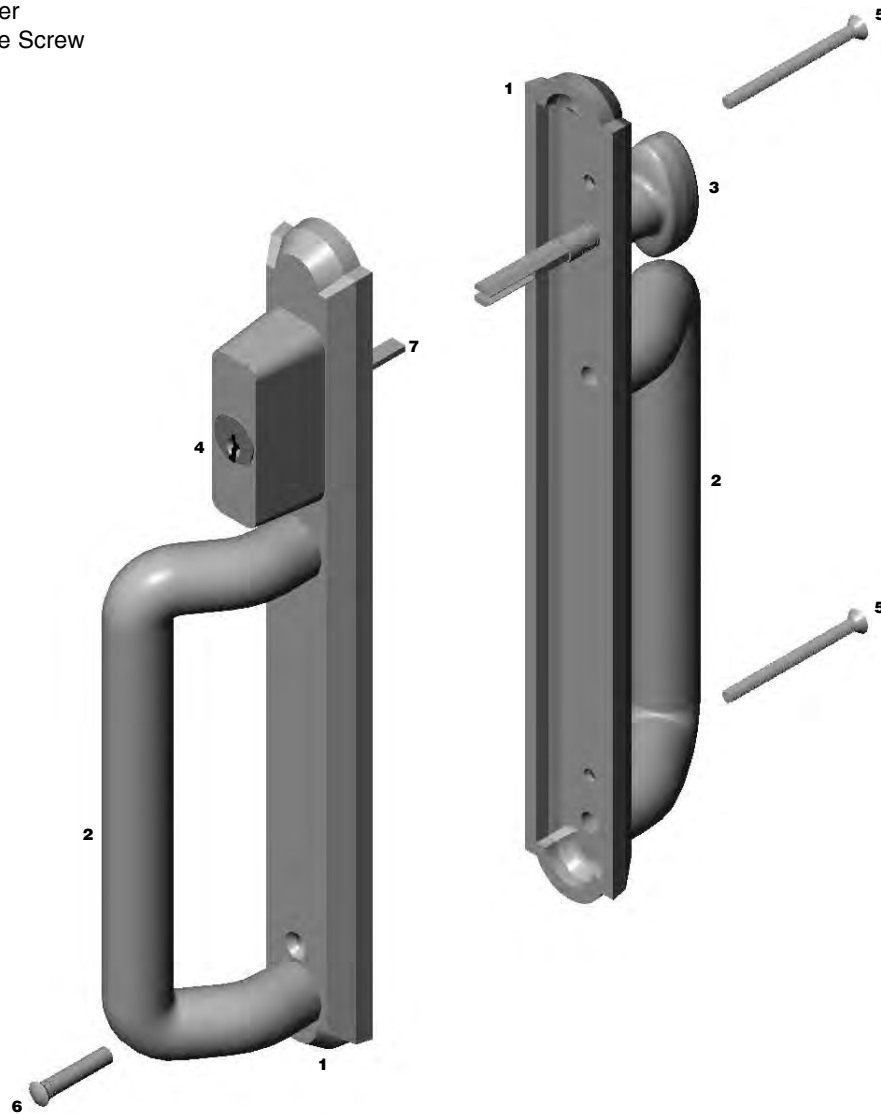

Entry Sliding Door Lock

- 1 Flush Pull
- 2 Mortise Cylinder
- 3 Turn Piece
- 4 Sliding Door Lock
- 5 Scalp
- 6 Sliding Door Lock Strike
- 7 Dust Box

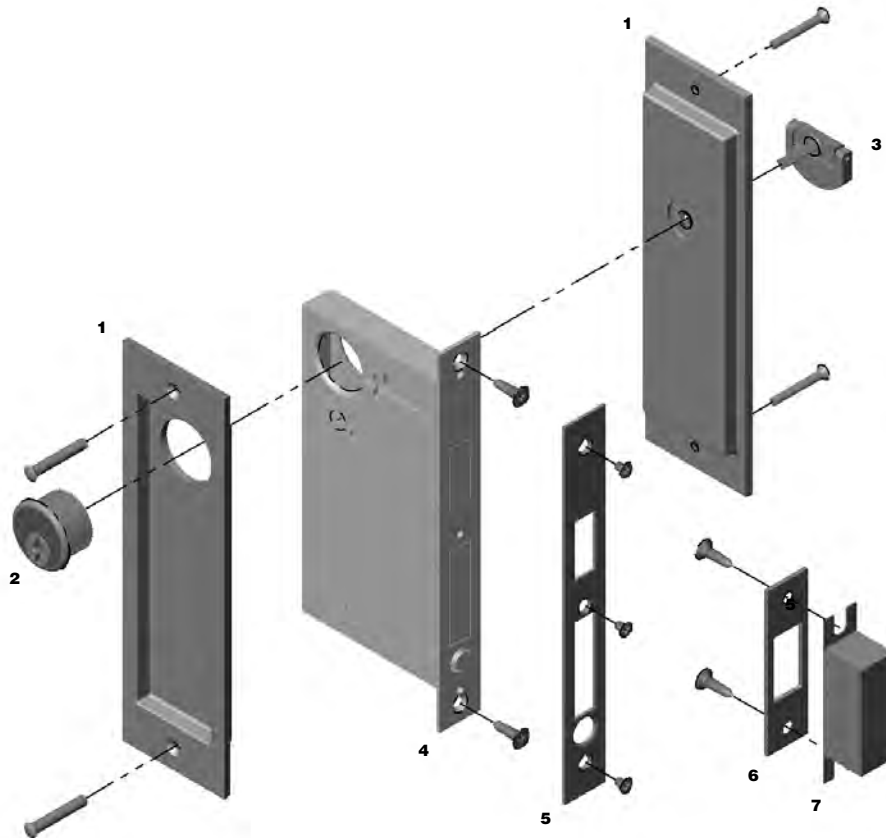

Sliding Door Information

1. Manufacture _____

(Pella, Marvin, etc.)

2. Function _____

(Patio, Entry, or Dummy)

3. Stile Width _____

(Inches)

4. Back Set _____

(Inches)

5. Back Set _____
From jamb with door closed

(Inches)

6. Door thickness _____

(Inches)

7. Mounting hole location from turn piece.
a. Use existing mounting holes?
b. Use sexbolts?

(Provide hand sketch w/ dimensions below)
Yes No
Yes No

8. Escutcheon
a. Type _____
b. Size _____

(Example: Arched)
(Height x Width)

9. Grip Type _____

(Example: SDP6)

10. Hand sketch insert orientation with door in the unlocked position, include dimensions.

Examples of typical inserts & orientations:

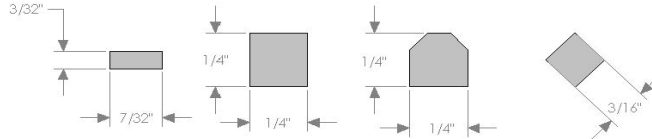

11. Hardware projection limitations?

(i.e. for screen door)

12. Handing? _____





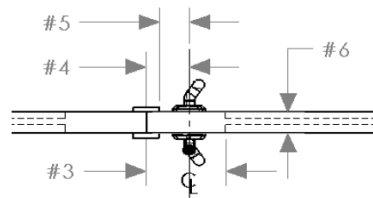

(OX, XO,... etc)

13. Further information/hand sketches







SLIDING DOOR PLAN VIEW









- All finishes are priced the same.
- Price includes SDP6 6" Offset D Grip, as shown, the SDT6 6" Offset Branch Grip, G258 6" Offset Rail Grip, G260 6" Offset Curved Rail Grip, G645 6" Offset Olympus, or G10810 6" Offset Briggs. When interference with screen door necessitates using a grip with less projection, the G830 should be used. Refer to Section A for grip specifications.
- Specify metal, patina, handing, backset, door thickness, and lock type.

	ACTIVE	DUMMY	ESCUTCHEON OPTIONS
A	 E468 E469	 E468 E468	A 1 3/8" x 11" Rectangular Escutcheon E468 / E469 Patio Sliding Door Trim . . . \$519.00 E468 / E468 Full Dummy \$449.00 • Includes TP800 Offset Turn Piece. Refer to spec page B10
B	 E444 E466	 E444 E444	B 1 3/4" x 11" Rectangular Escutcheon E444 / E466 Patio Sliding Door Trim . . . \$541.00 E444 / E444 Full Dummy \$471.00 • Includes TP800 Offset Turn Piece. Refer to spec page B10
C	 E485 E482  E484 E482	 E484 E484	C 1 3/8" x 11" Rectangular Escutcheon American Cylinder E485 / E482 Entry Sliding Door Trim . . . \$609.00 E484 / E482 Patio Sliding Door Trim . . . \$519.00 E484 / E484 Full Dummy \$449.00 • Entry Trim includes American Cylinder and TP600 Turn Piece. • Patio Trim includes TP600 Turn Piece. Refer to spec page B10





- All finishes are priced the same.
- Price includes SDP6 6" Offset D Grip, as shown, the SDT6 6" Offset Branch Grip, G258 6" Offset Rail Grip, G260 6" Offset Curved Rail Grip, G645 6" Offset Olympus, or G10810 6" Offset Briggs. When interference with screen door necessitates using a grip with less projection, the G830 should be used. Refer to Section A for grip specifications.
- Specify metal, patina, handing, backset, door thickness, and lock type.

	ACTIVE	DUMMY	ESCUTCHEON OPTIONS
A	 E498 E497		A 1 3/4" x 13" Rectangular Escutcheon American Cylinder E498 / E497 Entry Sliding Door Trim . . . \$653.00 E496 / E497 Patio Sliding Door Trim . . . \$563.00 E496 / E496 Full Dummy \$493.00 • Entry Trim includes American Cylinder and TP600 Turn Piece. • Patio Trim includes TP600 Turn Piece. Refer to spec page B11
	 E496 E497	 E496 E496	B 2 1/2" x 13" Rectangular Escutcheon E490 / E491 Patio Sliding Door Trim . . . \$579.00 E490 / E490 Full Dummy \$509.00 • Patio Trim includes TP600 Turn Piece Refer to spec page B11
B	 E490 E491	 E490 E490	C 2 1/2" x 13" Rectangular Escutcheon E493 / E494 Patio Sliding Door Trim . . . \$579.00 E493 / E493 Full Dummy \$509.00 • Patio Trim includes TP600 Turn Piece Refer to spec page B11
C	 E493 E494	 E493 E493	





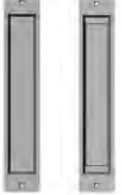



- All finishes are priced the same.
- Price includes L124 Offset Lever, as shown, or L177 Offset Tube Lever. Refer to Section A for lever specifications.
- Specify metal, patina, handing, backset, door thickness, lock type and center-to-center dimension.

ACTIVE	DUMMY	ESCUTCHEON OPTIONS
<p>A</p>  <p>E440 E440</p>		<p>A 1 3/8" x 11" Rectangular Escutcheon Profile Cylinder E440 / E440 Entry Sliding Door Trim* . . \$724.00 E456 / E440 Patio Sliding Door Trim* . . \$671.00 E456 / E456 Full Dummy \$512.00</p> <ul style="list-style-type: none"> • Entry Trim includes Profile Cylinder with TP600 Turn Piece and 8mm Spindle. • Patio Trim includes 1/2 Profile Cylinder with TP600 Turn Piece and 8mm Spindle. Refer to spec page B10
 <p>E456 E440</p>	 <p>E456 E456</p>	<p>B 1 3/4" x 11" Rectangular Escutcheon Profile Cylinder E449 / E449 Entry Sliding Door Trim* . . \$746.00 E446 / E449 Patio Sliding Door Trim* . . \$693.00 E446 / E446 Full Dummy \$534.00</p> <ul style="list-style-type: none"> • Entry Trim includes Profile Cylinder with TP600 Turn Piece and 8mm Spindle. • Patio Trim includes 1/2 Profile Cylinder with TP600 Turn Piece and 8mm Spindle. Refer to spec page B10
<p>B</p>  <p>E449 E449</p>		<p>* The center-to-center dimension will need to be verified before set can be ordered.</p>
 <p>E446 E449</p>	 <p>E446 E446</p>	







- All finishes are priced the same.
- Price includes your choice of lever (L114, L138, L139, L142, L144, L145, L146, L148, L149, L167, L168, L172, L173, L176, L180, or L21075).
Refer to Section A for lever specifications.
- Combination is shown with L148 Long French Lever for illustration purposes.
- Specify metal, patina, handing, backset, door thickness, and lock type.

ACTIVE	DUMMY	ESCUTCHEON OPTIONS
<p>A</p>  <p>FP208 E446</p>		<p>A 1 3/4" x 11" Rectangular Lift & Slide Escutcheon / 2 1/2" x 8" Rectangular Flush Pull FP208 / E446 Lift and Slide Trim with Flush Pull \$ 431.00 E446 Lift and Slide Trim \$ 335.00</p> <ul style="list-style-type: none"> • Includes 10mm Spindle. <p>Refer to spec pages B10 and I36</p>
 <p>E446</p>		<p>B 2" x 11" Rectangular Folding Lift & Slide Escutcheon / 2" x 11" Rectangular Flush Pull FP256 / LSF256 Folding Lift and Slide Trim with Flush Pull \$ 502.00 LSF256 Folding Lift and Slide Trim . . . \$ 375.00</p> <ul style="list-style-type: none"> • Includes 10mm Spindle. <p>Refer to spec page I35</p>
<p>B</p>  <p>FP256 LSF256</p>		
 <p>LSF256</p>		









- All finishes are priced the same.
- Price includes SDP6 6" Offset D Grip, as shown, the SDT6 6" Offset Branch Grip, G258 6" Offset Rail Grip, G260 6" Offset Curved Rail Grip, G645 6" Offset Olympus, or G10810 6" Offset Briggs. When interference with screen door necessitates using a grip with less projection, the G830 should be used. Refer to Section A for grip specifications.
- Specify metal, patina, handing, backset, door thickness, and lock type.

	ACTIVE	DUMMY	ESCUTCHEON OPTIONS
A	 E318 E319	 E318 E318	A 1 3/8" x 11" Stepped Escutcheon E318 / E319 Patio Sliding Door Trim . . . \$519.00 E318 / E318 Full Dummy \$449.00 • Patio Trim includes TP800 Offset Turn Piece. Refer to spec page B20
B	 E351 E352	 E351 E351	B 1 3/4" x 11" Stepped Escutcheon E351 / E352 Patio Sliding Door Trim . . . \$541.00 E351 / E351 Full Dummy \$471.00 • Patio Trim includes TP800 Offset Turn Piece. Refer to spec page B21
C	 E326 E321  E320 E321	 E351 E351  E320 E320	C 1 3/8" x 11" Stepped Escutcheon American Cylinder E326 / E321 Entry Sliding Door Trim . . . \$609.00 E320 / E321 Patio Sliding Door Trim . . . \$519.00 E320 / E320 Full Dummy \$449.00 • Entry Trim includes American Cylinder and TP700 Turn Piece. • Patio Trim includes TP700 Turn Piece. Refer to spec page B20

- All finishes are priced the same.
- Price includes SDP6 6" Offset D Grip, as shown, the SDT6 6" Offset Branch Grip, G258 6" Offset Rail Grip, G260 6" Offset Curved Rail Grip, G645 6" Offset Olympus, or G10810 6" Offset Briggs. When interference with screen door necessitates using a grip with less projection, the G830 should be used. Refer to Section A for grip specifications.
- Specify metal, patina, handing, backset, door thickness, and lock type.

	ACTIVE	DUMMY	ESCUTCHEON OPTIONS
A			A 1 3/8" x 13" Stepped Escutcheon American Cylinder E372 / E371 Entry Sliding Door Trim . . . \$630.00 E370 / E371 Patio Sliding Door Trim . . . \$541.00 E370 / E370 Full Dummy \$471.00 • Entry Trim includes American Cylinder and TP700 Turn Piece. • Patio Trim includes TP700 Turn Piece. Refer to spec page B20
	E372 E371		
			B 1 3/4" x 13" Stepped Escutcheon American Cylinder E343 / E342 Entry Sliding Door Trim . . . \$653.00 E341 / E342 Patio Sliding Door Trim . . . \$563.00 E341 / E341 Full Dummy \$493.00 • Entry Trim includes American Cylinder and TP700 Turn Piece. • Patio Trim includes TP700 Turn Piece. Refer to spec page B21
	E370 E371	E370 E370	
B			
	E343 E342		
			
	E341 E342	E341 E341	

- All finishes are priced the same.
- Price includes L124 Offset Lever, as shown, or L177 Offset Tube Lever.
Refer to Section A for lever specifications.
- Specify metal, patina, handing, backset, door thickness, lock type and center-to-center dimension.

ACTIVE	DUMMY	ESCUTCHEON OPTIONS
<p>A</p>  <p>E374 E374</p>		<p>A 1 3/8" x 11" Stepped Escutcheon Profile Cylinder E374 / E374 Entry Sliding Door Trim* . . \$724.00 E376 / E374 Patio Sliding Door Trim* . . \$671.00 E376 / E376 Full Dummy. \$512.00</p> <ul style="list-style-type: none"> • Entry Trim includes Profile Cylinder with TP700 Turn Piece and 8mm Spindle. • Patio Trim includes 1/2 Profile Cylinder with TP700 Turn Piece and 8mm Spindle. Refer to spec page B20
 <p>E376 E374</p>	 <p>E376 E376</p>	<p>B 1 3/4" x 11" Stepped Escutcheon Profile Cylinder E333 / E333 Entry Sliding Door Trim* . . \$746.00 E330 / E333 Patio Sliding Door Trim* . . \$693.00 E330 / E330 Full Dummy. \$534.00</p> <ul style="list-style-type: none"> • Entry Trim includes Profile Cylinder with TP700 Turn Piece and 8mm Spindle. • Patio Trim includes 1/2 Profile Cylinder with TP700 Turn Piece and 8mm Spindle. Refer to spec page B21
<p>B</p>  <p>E333 E333</p>		<p>* The center-to-center dimension will need to be verified before set can be ordered.</p>
 <p>E330 E333</p>	 <p>E330 E330</p>	

- All finishes are priced the same.
- Price includes your choice of lever (L114, L138, L139, L142, L144, L145, L146, L148, L149, L167, L168, L172, L173, L176, L180, or L21075).
Refer to Section A for lever specifications.
- Combination is shown with L148 Long French Lever for illustration purposes.
- Specify metal, patina, handing, backset, door thickness, and lock type.

A



B



A 1 3/4" x 11" Stepped Lift & Slide Escutcheon / 2 1/2" x 8" Rectangular Flush Pull

FP208 / E330 Lift and Slide Trim with
Flush Pull \$ 431.00
E330 Active Trim \$ 335.00







- Includes 10mm Spindle.
Refer to spec pages B21 and I36

B 2" x 11" Rectangular Folding Lift & Slide Escutcheon / 2" x 11" Rectangular Flush Pull

FP256 / LSF256 Folding Lift and Slide Trim
with Flush Pull \$ 502.00
LSF256 Folding Lift and Slide Trim . . . \$ 375.00

- Includes 10mm Spindle.
Refer to spec page I35

- All finishes are priced the same.
- Price includes SDP6 6" Offset D Grip, SDT6 6" Offset Branch Grip, G258 6" Offset Rail Grip, G260 6" Offset Curved Rail Grip, as shown, G645 6" Offset Olympus, or G10810 6" Offset Briggs. When interference with screen door necessitates using a grip with less projection, the G830 should be used. Refer to Section A for grip specifications.
- Specify metal, patina, handing, backset, door thickness, and lock type.
 Note: To compliment the Designer Series with Sliding Door Hardware, RMH recommends utilizing the Metro Collection.

	ACTIVE	DUMMY	ESCUTCHEON OPTIONS
A	 E218 E219	 E218 E218	A 1 3/8" x 11" Metro Escutcheon E218 / E219 Patio Sliding Door Trim . . . \$519.00 E218 / E218 Full Dummy \$449.00 • Patio Trim includes TP200 Turn Piece. Refer to spec page B31
B	 E227 E228	 E227 E227	B 1 3/4" x 11" Metro Escutcheon E227 / E228 Patio Sliding Door Trim . . . \$541.00 E227 / E227 Full Dummy \$471.00 • Patio Trim includes TP200 Turn Piece. Refer to spec page B32
C	 E235 E234  E220 E234	 E220 E220	C 1 3/8" x 11" Metro Escutcheon American Cylinder E235 / E234 Entry Sliding Door Trim . . . \$609.00 E220 / E234 Patio Sliding Door Trim . . . \$519.00 E220 / E220 Full Dummy \$449.00 • Entry Trim includes American Cylinder and TP200 Turn Piece. • Patio Trim includes TP200 Turn Piece. Refer to spec page B31

- All finishes are priced the same.
- Price includes SDP6 6" Offset D Grip, SDT6 6" Offset Branch Grip, G258 6" Offset Rail Grip, G260 6" Offset Curved Rail Grip, as shown, G645 6" Offset Olympus, or G10810 6" Offset Briggs. When interference with screen door necessitates using a grip with less projection, the G830 should be used. Refer to Section A for grip specifications.
- Specify metal, patina, handing, backset, door thickness, and lock type.
 Note: To compliment the Designer Series with Sliding Door Hardware, RMH recommends utilizing the Metro Collection.

ACTIVE

DUMMY

ESCUTCHEON OPTIONS

A



E223 E222



E221 E222

B



E226 E225

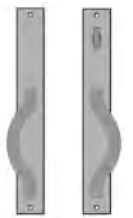

E224 E225



E221 E221



E224 E224

A 1 3/4" x 11" Metro Escutcheon

American Cylinder

- E223 / E222 Entry Sliding Door Trim . . . \$630.00
- E221 / E222 Patio Sliding Door Trim . . . \$541.00
- E221 / E221 Full Dummy \$471.00

- Entry Trim includes American Cylinder and TP200 Turn Piece.
- Patio Trim includes TP200 Turn Piece.
 Refer to spec page B32









B 1 3/4" x 13" Metro Escutcheon

American Cylinder





- E226 / E225 Entry Sliding Door Trim . . . \$653.00
- E224 / E225 Patio Sliding Door Trim . . . \$563.00
- E224 / E224 Full Dummy \$493.00

- Entry Trim includes American Cylinder and TP200 Turn Piece.
- Patio Trim includes TP200 Turn Piece.
 Refer to spec page B32





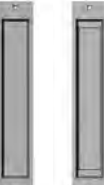

- All finishes are priced the same.
- Price includes L124 Offset Lever, as shown, or L177 Offset Tube Lever. Refer to Section A for lever specifications.
- Specify metal, patina, handing, backset, door thickness, lock type and center-to-center dimension.

ACTIVE	DUMMY	ESCUTCHEON OPTIONS
<p>A</p>  <p>E275 E275</p>	 <p>E270 E270</p>	<p>A 1 3/8" x 11" Metro Escutcheon Profile Cylinder E275 / E275 Entry Sliding Door Trim* . . \$724.00 E270 / E275 Patio Sliding Door Trim* . . \$671.00 E270 / E270 Full Dummy \$512.00</p> <ul style="list-style-type: none"> • Entry Trim includes Profile Cylinder with TP200 Turn Piece and 8mm Spindle. • Patio Trim includes 1/2 Profile Cylinder with TP200 Turn Piece and 8mm Spindle. Refer to spec page B31
 <p>E270 E275</p>	 <p>E270 E270</p>	<p>B 1 3/4" x 11" Metro Escutcheon Profile Cylinder E248 / E248 Entry Sliding Door Trim* . . \$746.00 E241 / E248 Patio Sliding Door Trim* . . \$693.00 E241 / E241 Full Dummy \$534.00</p> <ul style="list-style-type: none"> • Entry Trim includes Profile Cylinder with TP200 Turn Piece and 8mm Spindle. • Patio Trim includes 1/2 Profile Cylinder with TP200 Turn Piece and 8mm Spindle. Refer to spec page B32
<p>B</p>  <p>E248 E248</p>	 <p>E241 E241</p>	<p>* The center-to-center dimension will need to be verified before set can be ordered.</p>
 <p>E241 E248</p>	 <p>E241 E241</p>	

- All finishes are priced the same.
- Price includes your choice of lever (L114, L138, L139, L142, L144, L145, L146, L148, L149, L167, L168, L172, L173, L176, L180, or L21075). Refer to Section A for lever specifications.
- Combination is shown with L148 Long French Lever for illustration purposes.
- Specify metal, patina, handing, backset, door thickness, and lock type.

ACTIVE	DUMMY	ESCUTCHEON OPTIONS
<p>A</p>  <p>FP208 E241</p>		<p>A 1 3/4" x 11" Metro Lift & Slide Escutcheon / 2 1/2" x 8" Rectangular Flush Pull FP208 / E241 Lift and Slide Trim with Flush Pull \$431.00 E241 Lift and Slide Trim \$335.00</p> <ul style="list-style-type: none"> • Includes 10mm Spindle. <p>Refer to spec pages B32 and I36</p>
 <p>E241</p>		<p>B 2" x 11" Rectangular Folding Lift & Slide Escutcheon / 2" x 11" Rectangular Flush Pull FP256 / LSF256 Folding Lift and Slide Trim with Flush Pull \$502.00 LSF256 Folding Lift and Slide Trim . . . \$375.00</p> <ul style="list-style-type: none"> • Includes 10mm Spindle. <p>Refer to spec page I35</p>
<p>B</p>  <p>FP256 LSF256</p>		
 <p>LSF256</p>		

- All finishes are priced the same.
- Price includes SDP6 6" Offset D Grip, as shown, the SDT6 6" Offset Branch Grip, G258 6" Offset Rail Grip, G260 6" Offset Curved Rail Grip, G645 6" Offset Olympus, or G10810 6" Offset Briggs. When interference with screen door necessitates using a grip with less projection, the G830 should be used. Refer to Section A for grip specifications.
- Specify metal, patina, handing, backset, door thickness, and lock type.

	ACTIVE	DUMMY	ESCUTCHEON OPTIONS
A	 E708 E709	 E708 E708	<p>A 1 3/8" x 11" Arched Escutcheon E708 / E709 Patio Sliding Door Trim . . . \$519.00 E708 / E708 Full Dummy \$449.00</p> <ul style="list-style-type: none"> • Patio Trim includes TP800 Offset Turn Piece. Refer to spec page B43
B	 E760 E762	 E760 E760	<p>B 1 3/4" x 11" Arched Escutcheon E760 / E762 Patio Sliding Door Trim . . . \$541.00 E760 / E760 Full Dummy \$471.00</p> <ul style="list-style-type: none"> • Patio Trim includes TP800 Offset Turn Piece. Refer to spec page B43
C	 E714 E717  E715 E717	 E715 E715	<p>C 1 3/8" x 11" Arched Escutcheon American Cylinder E714 / E717 Entry Sliding Door Trim . . . \$609.00 E715 / E717 Patio Sliding Door Trim . . . \$519.00 E715 / E715 Full Dummy \$449.00</p> <ul style="list-style-type: none"> • Entry Trim includes American Cylinder and TP600 Turn Piece. • Patio Trim includes TP600 Turn Piece. Refer to spec page B43

- All finishes are priced the same.
- Price includes SDP6 6" Offset D Grip, as shown, the SDT6 6" Offset Branch Grip, G258 6" Offset Rail Grip, G260 6" Offset Curved Rail Grip, G645 6" Offset Olympus, or G10810 6" Offset Briggs. When interference with screen door necessitates using a grip with less projection, the G830 should be used. Refer to Section A for grip specifications.
- Specify metal, patina, handing, backset, door thickness, and lock type.

ACTIVE

DUMMY

ESCUTCHEON OPTIONS

A



E798 E797



E796 E797



E796 E796

A 1 3/4" x 13" Arched Escutcheon

American Cylinder





E798 / E797 Entry Sliding Door Trim . . . \$653.00

E796 / E797 Patio Sliding Door Trim . . . \$563.00







E796 / E796 Full Dummy. \$493.00

- Entry Trim includes American Cylinder and TP600 Turn Piece.
- Patio Trim includes TP600 Turn Piece.
Refer to spec page B44





- All finishes are priced the same.
- Price includes SDP6 6" Offset D Grip, as shown, the SDT6 6" Offset Branch Grip, G258 6" Offset Rail Grip, G260 6" Offset Curved Rail Grip, G645 6" Offset Olympus, or G10810 6" Offset Briggs. When interference with screen door necessitates using a grip with less projection, the G830 should be used. Refer to Section A for grip specifications.
- Specify metal, patina, handing, backset, door thickness, and lock type.

	ACTIVE	DUMMY	ESCUTCHEON OPTIONS
A	 E790 E791	 E790 E790	A 2 1/2" x 13" Arched Escutcheon E790 / E791 Patio Sliding Door Trim . . . \$579.00 E790 / E790 Full Dummy \$509.00 • Patio Trim includes TP600 Turn Piece. Refer to spec page B44
B	 E793 E794	 E793 E793	B 2 1/2" x 13" Arched Escutcheon E793 / E794 Patio Sliding Door Trim . . . \$579.00 E793 / E793 Full Dummy \$509.00 • Patio Trim includes TP600 Turn Piece. Refer to spec page B44





- All finishes are priced the same.
- Price includes L124 Offset Lever, as shown, or L177 Offset Tube Lever. Refer to Section A for lever specifications.
- Specify metal, patina, handing, backset, door thickness, lock type and center-to-center dimension.

	ACTIVE	DUMMY	ESCUTCHEON OPTIONS
A	 E720 E720		A 1 3/8" x 11" Arched Escutcheon Profile Cylinder E720 / E720 Entry Sliding Door Trim* . . \$724.00 E718 / E720 Patio Sliding Door Trim* . . \$671.00 E718 / E718 Full Dummy. \$512.00 • Entry Trim includes Profile Cylinder with TP600 Turn Piece and 8mm Spindle. • Patio Trim includes 1/2 Profile Cylinder with TP600 Turn Piece and 8mm Spindle. Refer to spec page B43
	 E718 E720	 E718 E718	
B	 E740 E740		B 1 3/4" x 11" Arched Escutcheon Profile Cylinder E740 / E740 Entry Sliding Door Trim* . . \$746.00 E746 / E740 Patio Sliding Door Trim* . . \$693.00 E746 / E746 Full Dummy. \$534.00 • Entry Trim includes Profile Cylinder with TP600 Turn Piece and 8mm Spindle. • Patio Trim includes 1/2 Profile Cylinder with TP600 Turn Piece and 8mm Spindle. Refer to spec page B43 * The center-to-center dimension will need to be verified before set can be ordered.
	 E746 E740	 E746 E746	

- All finishes are priced the same.
- Price includes your choice of lever (L114, L138, L139, L142, L144, L145, L146, L148, L149, L167, L168, L172, L173, L176, L180, or L21075).
Refer to Section A for lever specifications.
- Combination is shown with L148 Long French Lever for illustration purposes.
- Specify metal, patina, handing, backset, door thickness, and lock type.

ACTIVE	DUMMY	ESCUTCHEON OPTIONS
<p>A</p>  <p>FP259 E746</p>		<p>A 1 3/4" x 11" Arched Lift & Slide Escutcheon / 2 1/2" x 9" Flush Pull FP259 / E746 Lift and Slide Trim with Flush Pull \$443.00 E746 Lift and Slide Trim \$335.00</p> <ul style="list-style-type: none"> • Includes 10mm Spindle. <p>Refer to spec pages B43 and I39</p>
 <p>E746</p>		<p>B 2" x 11" Rectangular Folding Lift & Slide Escutcheon / 2" x 11" Rectangular Flush Pull FP256 / LSF256 Folding Lift and Slide Trim with Flush Pull \$502.00 LSF256 Folding Lift and Slide Trim . . . \$375.00</p> <ul style="list-style-type: none"> • Includes 10mm Spindle. <p>Refer to spec page I35</p>
<p>B</p>  <p>FP256 LSF256</p>		
 <p>LSF256</p>		

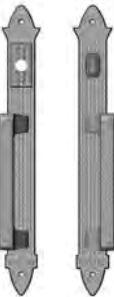

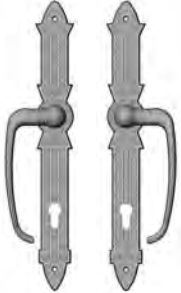
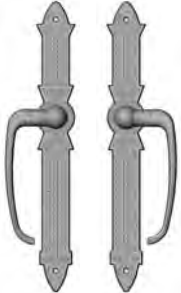
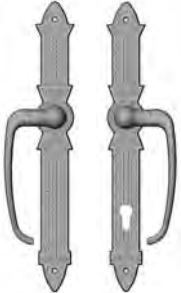

- All finishes are priced the same.
- Price includes SDP6 6" Offset D Grip, the SDT6 6" Offset Branch Grip, G258 6" Offset Rail Grip, G260 6" Offset Curved Rail Grip, G645 6" Offset Olympus, or G10810 6" Offset Briggs, as shown. When interference with screen door necessitates using a grip with less projection, the G830 should be used. Refer to Section A for grip specifications.
- Specify metal, patina, handing, backset, door thickness, and lock type.

	ACTIVE	DUMMY	ESCUTCHEON OPTIONS
A	 E10879 E10880	 E10879 E10879	A 2" x 15" Briggs Escutcheon E10879 / E10880 Patio Sliding Door Trim. \$ 541.00 E10879 / E10879 Full Dummy. \$ 471.00 • Includes TP10801 Turn Piece. Refer to spec page B64
B	 E10881 E10882  E10883 E10882	 E10883 E10883	B 2" x 15" Briggs Escutcheon American Cylinder E10881 / E10882 Entry Sliding Door Trim. \$ 631.00 E10883 / E10882 Patio Sliding Door Trim. \$ 541.00 E10883 / E10883 Full Dummy. \$ 471.00 • Entry Trim includes American cylinder and TP10801 turn piece. • Patio Trim includes TP10801 turn piece. Refer to spec page B64







- All finishes are priced the same.
- Price includes L124 Offset Lever, as shown, or L177 Offset Tube Lever. Refer to Section A for lever specifications.
- Specify metal, patina, handing, backset, door thickness, and lock type.

ACTIVE	DUMMY	ESCUTCHEON OPTIONS
<p>A</p>  <p>E10885 E10885</p>	 <p>E10871 E10871</p>	<p>A 2" x 15" Briggs Escutcheon Profile Cylinder</p> <p>E10885 / E10885 Entry Sliding Door Trim* \$ 746.00 E10871 / E10885 Patio Sliding Door Trim* \$ 693.00 E10871 / E10871 Full Dummy. \$ 534.00</p> <ul style="list-style-type: none"> • Entry Trim includes Profile cylinder with TP10801 turn piece and 8mm Spindle. • Patio Trim includes 1/2 Profile cylinder with TP10801 turn piece and 8mm Spindle. Refer to spec page B64 <p>* The center-to-center dimension will need to be verified before set can be ordered.</p>
 <p>E10871 E10885</p>		

- All finishes are priced the same.
- Price includes your choice of lever (L114, L138, L139, L142, L144, L145, L146, L148, L149, L167, L168, L172, L173, L176, L180, or L21075).
Refer to Section A for lever specifications.
- Combination is shown with L148 Long French Lever for illustration purposes.
- Specify metal, patina, handing, backset, door thickness, and lock type.

ACTIVE	DUMMY	ESCUTCHEON OPTIONS
<p>A</p>  <p>FP259 E10871</p>  <p>E10871</p>		<p>A 2" x 15" Briggs Lift & Slide Escutcheon 2 1/2" x 9" Arched Flush Pull</p> <p>FP259 / E10871 Lift & Slide Trim \$ 443.00 with Flush pull E10871 Lift & Slide Trim \$ 335.00</p> <ul style="list-style-type: none"> • Includes 10mm Spindle. Refer to spec page B64 and I39 <p>B 2" x 11" Rectangular Folding Lift & Slide Escutcheon / 2" x 11" Rectangular Flush Pull</p> <p>FP256 / LSF256 Folding Lift and Slide Trim with Flush Pull \$502.00 LSF256 Folding Lift and Slide Trim . . . \$375.00</p> <ul style="list-style-type: none"> • Includes 10mm Spindle. Refer to spec page I35
<p>B</p>  <p>FP256 LSF256</p>  <p>LSF256</p>		

- All finishes are priced the same.
- Price includes SDP6 6" Offset D Grip, as shown, the SDT6 6" Offset Branch Grip, G258 6" Offset Rail Grip, G260 6" Offset Curved Rail Grip, G645 6" Offset Olympus, or G10810 6" Offset Briggs. When interference with screen door necessitates using a grip with less projection, the G830 should be used. Refer to Section A for grip specifications.
- Specify metal, patina, handing, backset, door thickness, and lock type.

	ACTIVE	DUMMY	ESCUTCHEON OPTIONS
A	 E518 E519	 E518 E518	A 1 3/8" x 11" Curved Escutcheon E518 / E519 Patio Sliding Door Trim . . . \$519.00 E518 / E518 Full Dummy \$449.00 • Patio Trim includes TP800 Offset Turn Piece. Refer to spec page B52
B	 E551 E552	 E551 E551	B 1 3/4" x 11" Curved Escutcheon E551 / E552 Patio Sliding Door Trim . . . \$541.00 E551 / E551 Full Dummy \$471.00 • Patio Trim includes TP800 Offset Turn Piece. Refer to spec page B52
C	 E526 E521  E520 E521	 E520 E520	C 1 3/8" x 11" Curved Escutcheon American Cylinder E526 / E521 Entry Sliding Door Trim . . . \$609.00 E520 / E521 Patio Sliding Door Trim . . . \$519.00 E520 / E520 Full Dummy \$449.00 • Entry Trim includes American Cylinder and TP700 Turn Piece. • Patio Trim includes TP700 Turn Piece. Refer to spec page B52

- All finishes are priced the same.
- Price includes SDP6 6" Offset D Grip, as shown, the SDT6 6" Offset Branch Grip, G258 6" Offset Rail Grip, G260 6" Offset Curved Rail Grip, G645 6" Offset Olympus, or G10810 6" Offset Briggs. When interference with screen door necessitates using a grip with less projection, the G830 should be used. Refer to Section A for grip specifications.
- Specify metal, patina, handing, backset, door thickness, and lock type.

ACTIVE

DUMMY

ESCUTCHEON OPTIONS

A



E563 E562



E561 E562









E561 E561









**A 1 3/4" x 13" Curved Escutcheon
American Cylinder**

- E563 / E562 Entry Sliding Door Trim . . . \$653.00
- E561 / E562 Patio Sliding Door Trim . . . \$563.00
- E561 / E561 Full Dummy \$493.00
- Entry Trim includes American Cylinder and TP700 Turn Piece.
- Patio Trim includes TP700 Turn Piece.
Refer to spec page B53



- All finishes are priced the same.
- Price includes L124 Offset Lever, as shown, or L177 Offset Tube Lever. Refer to Section A for lever specifications.
- Specify metal, patina, handing, backset, door thickness, lock type and center-to-center dimension.

	ACTIVE	DUMMY	ESCUTCHEON OPTIONS
A	 <p>E564 E564</p>		<p>A 1 3/8" x 11" Curved Escutcheon Profile Cylinder E564 / E564 Entry Sliding Door Trim* . . \$724.00 E576 / E564 Patio Sliding Door Trim* . . \$671.00 E576 / E576 Full Dummy \$512.00</p> <ul style="list-style-type: none"> • Entry Trim includes Profile Cylinder with TP600 Turn Piece and 8mm Spindle. • Patio Trim includes 1/2 Profile Cylinder with TP600 Turn Piece and 8mm Spindle. <p>Refer to spec page B52</p>
	 <p>E576 E564</p>	 <p>E576 E576</p>	
B	 <p>E533 E533</p>		<p>B 1 3/4" x 11" Curved Escutcheon Profile Cylinder E533 / E533 Entry Sliding Door Trim* . . \$746.00 E530 / E533 Patio Sliding Door Trim* . . \$693.00 E530 / E530 Full Dummy \$534.00</p> <ul style="list-style-type: none"> • Entry Trim includes Profile Cylinder with TP700 Turn Piece and 8mm Spindle. • Patio Trim includes 1/2 Profile Cylinder with TP700 Turn Piece and 8mm Spindle. <p>Refer to spec page B52</p> <p>* The center-to-center dimension will need to be verified before set can be ordered.</p>
	 <p>E530 E533</p>	 <p>E530 E530</p>	



- All finishes are priced the same.
- Price includes your choice of lever (L114, L138, L139, L142, L144, L145, L146, L148, L149, L167, L168, L172, L173, L176, L180, or L21075).
Refer to Section A for lever specifications.
- Combination is shown with L148 Long French Lever for illustration purposes.
- Specify metal, patina, handing, backset, door thickness, and lock type.

	ACTIVE	DUMMY	ESCUTCHEON OPTIONS	
A			<p>A 1 3/4" x 11" Curved Lift & Slide Escutcheon/ 2 1/2" x 9" Curved Flush Pull FP249 / E530 Lift and Slide Trim with Flush Pull \$443.00 E530 Lift and Slide Trim \$335.00</p> <ul style="list-style-type: none"> • Include 10mm Spindle. <p>Refer to spec pages B52 and I41</p>	
				
				
B			<p>B 2" x 11" Rectangular Folding Lift & Slide Escutcheon / 2" x 11" Rectangular Flush Pull FP256 / LSF256 Folding Lift and Slide Trim with Flush Pull \$502.00 LSF256 Folding Lift and Slide Trim . . . \$375.00</p> <ul style="list-style-type: none"> • Includes 10mm Spindle. <p>Refer to spec page I35</p>	
				
				





- All finishes are priced the same.
- Price includes SDP6 6" Offset D Grip, as shown, the SDT6 6" Offset Branch Grip, G258 6" Offset Rail Grip, G260 6" Offset Curved Rail Grip, G645 6" Offset Olympus, or G10810 6" Offset Briggs. When interference with screen door necessitates using a grip with less projection, the G830 should be used. Refer to Section A for grip specifications.
- Specify metal, patina, handing, backset, door thickness, and lock type.

	ACTIVE	DUMMY	ESCUTCHEON OPTIONS
A	 <p style="margin-top: 5px;">E598 E599</p>	 <p style="margin-top: 5px;">E598 E598</p>	<p>A 1 3/4" x 11" Maddox Escutcheon</p> <p>E598 / E599 Patio Sliding Door Trim . . . \$644.00</p> <p>E598 / E598 Full Dummy \$575.00</p> <ul style="list-style-type: none"> • Patio Trim includes TP800 Offset Turn Piece. <p>Refer to spec page B67</p>



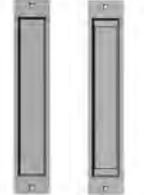

- All finishes are priced the same.
- Price includes L124 Offset Lever, as shown, or L177 Offset Tube Lever. Refer to Section A for lever specifications.
- Specify metal, patina, handing, backset, door thickness, lock type and center-to-center dimension.

ACTIVE	DUMMY	ESCUTCHEON OPTIONS
<p>A</p>  <p>E593 E593</p>	 <p>E591 E591</p>	<p>A 1 3/4" x 11" Maddox Escutcheon Profile Cylinder</p> <p>E593 / E593 Entry Sliding Door Trim* . . \$885.00 E591 / E593 Patio Sliding Door Trim* . . \$816.00 E591 / E591 Full Dummy \$638.00</p> <ul style="list-style-type: none"> • Entry Trim includes Profile Cylinder with TP580 Turn Piece and 8mm Spindle. • Patio Trim includes TP580 Turn Piece. Refer to spec page B67 <p>* The center-to-center dimension will need to be verified before set can be ordered.</p>
 <p>E591 E593</p>		



- All finishes are priced the same.
- Price includes your choice of lever (L114, L138, L139, L142, L144, L145, L146, L148, L149, L167, L168, L172, L173, L176, L180, or L21075).
Refer to Section A for lever specifications.
- Combination is shown with L148 Long French Lever for illustration purposes.
- Specify metal, patina, handing, backset, door thickness, and lock type.

ACTIVE	DUMMY	ESCUTCHEON OPTIONS
<p>A</p>  <p>FP249 E591</p>		<p>A 1 3/4" x 11" Maddox Lift & Slide Escutcheon/ 2 1/2" x 9" Curved Flush Pull FP249 / E591 Lift and Slide Trim with Flush Pull \$496.00 E591 Lift and Slide Trim \$388.00</p> <ul style="list-style-type: none"> • Includes 10mm Spindle. <p>Refer to spec pages B67 and I41</p>
 <p>E591</p>		<p>B 2" x 11" Rectangular Folding Lift & Slide Escutcheon / 2" x 11" Rectangular Flush Pull FP256 / LSF256 Folding Lift and Slide Trim with Flush Pull \$502.00 LSF256 Folding Lift and Slide Trim . . . \$375.00</p> <ul style="list-style-type: none"> • Includes 10mm Spindle. <p>Refer to spec page I35</p>
<p>B</p>  <p>FP256 LSF256</p>		
 <p>LSF256</p>		







- All finishes are priced the same.
- Price includes SDP6 6" Offset D Grip, as shown, the SDT6 6" Offset Branch Grip, G258 6" Offset Rail Grip, G260 6" Offset Curved Rail Grip, G645 6" Offset Olympus, or G10810 6" Offset Briggs. When interference with screen door necessitates using a grip with less projection, the G830 should be used. Refer to Section A for grip specifications.
- Specify metal, patina, handing, backset, door thickness, and lock type.

	ACTIVE	DUMMY	ESCUTCHEON OPTIONS
A	 E027 E028	 E027 E027	A 1 3/4" x 11" Ellis Escutcheon E027 / E028 Patio Sliding Door Trim . . . \$644.00 E027 / E027 Full Dummy \$575.00 • Patio Trim includes TP800 Turn Piece. Refer to spec page B75
B	 E023 E022  E021 E022	 E021 E021	B 1 3/4" x 11" Ellis Escutcheon American Cylinder E023 / E022 Entry Sliding Door Trim . . . \$734.00 E021 / E022 Patio Sliding Door Trim . . . \$644.00 E021 / E021 Full Dummy \$575.00 • Entry Trim includes American Cylinder and TP050 Turn Piece. • Patio Trim includes TP050 Turn Piece. Refer to spec page B75







- All finishes are priced the same.
- Price includes L124 Offset Lever, as shown, or L177 Offset Tube Lever. Refer to Section A for lever specifications.
- Specify metal, patina, handing, backset, door thickness, lock type and center-to-center dimension.

ACTIVE	DUMMY	ESCUTCHEON OPTIONS
<p>A</p>  <p>E048 E048</p>  <p>E041 E048</p>	 <p>E041 E041</p>	<p>A 1 3/4" x 11" Ellis Escutcheon Profile Cylinder</p> <p>E048 / E048 Entry Sliding Door Trim* . . \$885.00 E041 / E048 Patio Sliding Door Trim* . . \$816.00 E041 / E041 Full Dummy \$638.00</p> <ul style="list-style-type: none"> • Entry Trim includes Profile Cylinder with TP050 Turn Piece and 8mm Spindle. • Patio Trim includes 1/2 Profile Cylinder with TP050 Turn Piece and 8mm Spindle. Refer to spec page B75 <p>* The center-to-center dimension will need to be verified before set can be ordered.</p>

- All finishes are priced the same.
- Price includes your choice of lever (L114, L138, L139, L142, L144, L145, L146, L148, L149, L167, L168, L172, L173, L176, L180, or L21075).
Refer to Section A for lever specifications.
- Combination is shown with L148 Long French Lever for illustration purposes.
- Specify metal, patina, handing, backset, door thickness, and lock type.

	ACTIVE	DUMMY	ESCUTCHEON OPTIONS
A			A 1 3/4" x 11" Ellis Lift & Slide Escutcheon / 2 1/2" x 9" Arched Flush Pull FP259 / E041 Lift and Slide Trim with Flush Pull \$ 496.00 E041 Lift and Slide Trim \$ 388.00
	FP259		
			B 2" x 11" Rectangular Folding Lift & Slide Escutcheon / 2" x 11" Rectangular Flush Pull FP256 / LSF256 Folding Lift and Slide Trim with Flush Pull \$ 502.00 LSF256 Folding Lift and Slide Trim . . . \$ 375.00
		E041	
B			
	FP256		
			
		LSF256	

- All finishes are priced the same.
- Price includes SDP6 6" Offset D Grip, SDT6 6" Offset Branch Grip, G258 6" Offset Rail Grip, as shown, G260 6" Offset Curved Rail Grip, G645 6" Offset Olympus, or G10810 6" Offset Briggs. When interference with screen door necessitates using a grip with less projection, the G830 should be used. Refer to Section A for grip specifications.
- Specify metal, patina, handing, backset, door thickness, and lock type.

ACTIVE	DUMMY	ESCUTCHEON OPTIONS
<p>A</p>  <p>E21027 E21028</p>	 <p>E21027 E21027</p>	<p>A 1 3/4" x 13" Mack Escutcheon E21027 / E21028 Patio Sliding Door Trim . . \$ 563.00 E21027 / E21027 Full Dummy \$ 493.00</p> <ul style="list-style-type: none"> • Includes TP800 OffsetTurn Piece. <p>Refer to spec page B82</p>
<p>B</p>  <p>E21023 E21022</p>	 <p>E21021 E21021</p>	<p>B 1 3/4" x 13" Mack Escutcheon American Cylinder E21023 / E21022 Entry Sliding Door Trim . . \$ 653.00 E21021 / E21022 Patio Sliding Door Trim . . \$ 563.00 E21021 / E21021 Full Dummy \$ 493.00</p> <ul style="list-style-type: none"> • Entry Trim includes American Cylinder and TP200 Turn Piece. • Patio Trim includes TP200 Turn Piece. <p>Refer to spec page B82</p>
 <p>E21021 E21022</p>	 <p>E21021 E21021</p>	

- All finishes are priced the same.
- Price includes L124 Offset Lever, as shown, or L177 Offset Tube Lever. Refer to Section A for lever specifications.
- Specify metal, patina, handing, backset, door thickness, lock type and center-to-center dimension.

ACTIVE

DUMMY

ESCUTCHEON OPTIONS

A



E21048 E21048



E21041 E21048



E21041 E21041





A 1 3/4" x 11" Mack Escutcheon Profile Cylinder

- E21048 / E21048 Entry Sliding Door Trim* . . . \$ 746.00
- E21041 / E21048 Patio Sliding Door Trim * . . \$ 693.00
- E21041 / E21041 Full Dummy. \$ 534.00

- Entry Trim includes Profile Cylinder with TP200 Turn Piece and 8mm Spindle.
 - Patio Trim includes 1/2 Profile Cylinder with TP200 Turn Piece and 8mm Spindle.
- Refer to spec page B82

* The center-to-center dimension will need to be verified before set can be ordered.

- All finishes are priced the same.
- Price includes your choice of lever (L114, L138, L139, L142, L144, L145, L146, L148, L149, L167, L168, L172, L173, L176, L180, or L21075).
Refer to Section A for lever specifications.
- Combination is shown with L21075 Long Emile Lever for illustration purposes.
- Specify metal, patina, handing, backset, door thickness, and lock type.

ACTIVE	DUMMY	ESCUTCHEON OPTIONS
<p>A</p>  <p>FP208 E21041</p>		<p>A 1 3/4" x 11" Mack Lift & Slide Escutcheon / 2" x 8" Rectangular Flush Pull FP208 / E21041 Lift and Slide Trim with Flush Pull \$431.00 E21041 Lift and Slide Trim \$335.00</p> <ul style="list-style-type: none"> • Includes 10mm Spindle <p>Refer to spec page B82 and I36</p>
 <p>E21041</p>		<p>B 2" x 11" Rectangular Folding Lift & Slide Escutcheon / 2" x 11" Rectangular Flush Pull FP256 / LSF256 Folding Lift and Slide Trim with Flush Pull \$502.00 LSF256 Folding Lift and Slide Trim \$375.00</p> <ul style="list-style-type: none"> • Includes 10mm Spindle. <p>Refer to spec page I35</p>
<p>B</p>  <p>FP256 LSF256</p>		
 <p>LSF256</p>		

- All finishes are priced the same.
- Specify metal and patina.

Flush Pulls



FP216

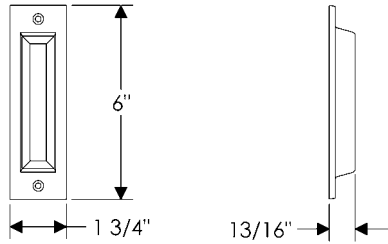

FP216 Flush Pull — Rectangular
 1 3/4" x 6" \$ 78.00

- **Note:** This will not work back-to-back on doors less than 1 3/4".



FP212

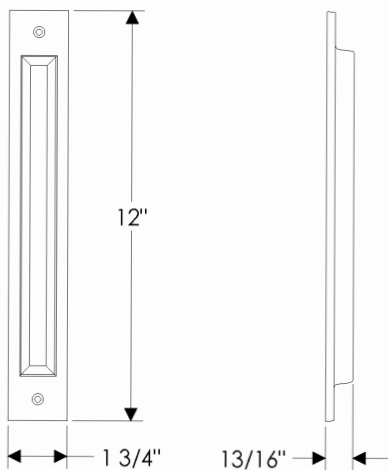

FP212 Flush Pull — Rectangular
 1 3/4" x 12" \$ 127.00

- **Note:** This will not work back-to-back on doors less than 1 3/4".

- All finishes are priced the same.
- Specify metal and patina.

Flush Pulls



FP217

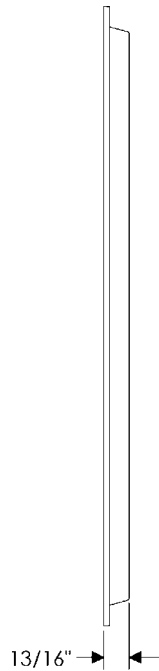
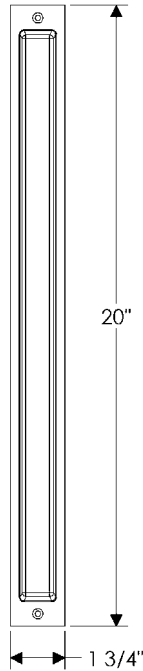

FP217 Flush Pull — Rectangular
 1 3/4" x 20" \$ 233.00

- **Note:** This will not work back-to-back on doors less than 1 3/4"



FP204

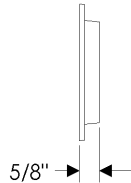
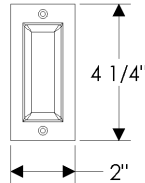

FP204 Flush Pull — Rectangular
 2" x 4 1/4" \$ 55.00

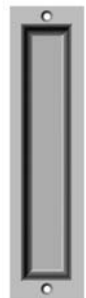

FP218

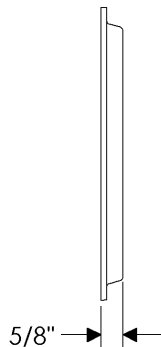
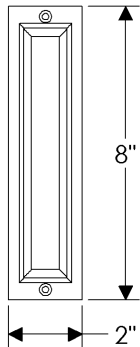

FP218 Flush Pull — Rectangular
 2" x 8" \$ 102.00

- All finishes are priced the same.
- Specify metal and patina.

Flush Pulls

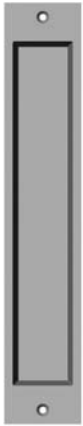

FP256

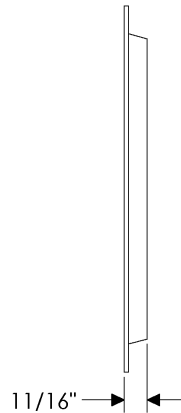
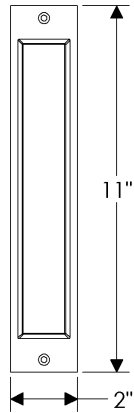

FP256 Flush Pull — Rectangular
 2" x 11" \$ 127.00

- **Note:** This will not work back-to-back on doors less than 1 1/2"



FP256

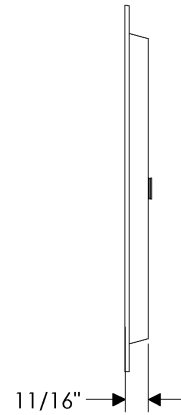
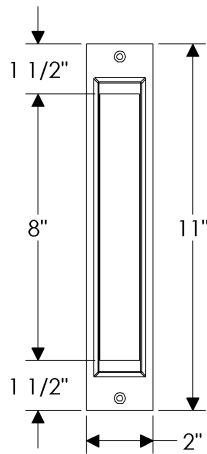

LSF256 Folding Lift & Slide — Rectangular
 2" x 11"

- Refer to page 14 for pricing & specifications

- All finishes are priced the same.
- Specify metal and patina.

Flush Pulls



FP251

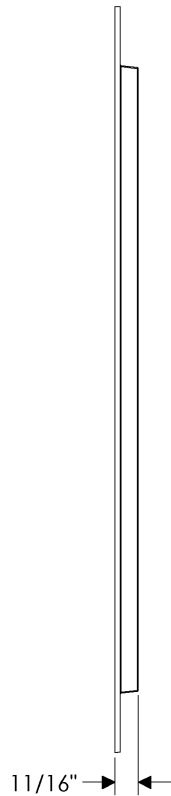
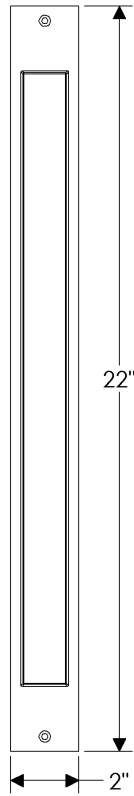

FP251 Flush Pull — Rectangular

2" x 22" \$ 240.00

- **Note:** This will not work back-to-back on doors less than 1 1/2"

- All finishes are priced the same.
- Specify metal and patina.

Flush Pulls



FP206

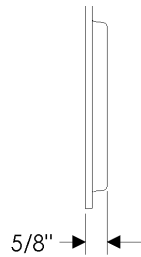
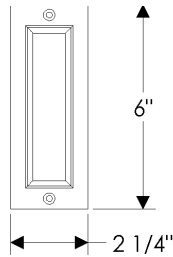

FP206 Flush Pull — Rectangular
 2 1/4" x 6" \$ 75.00



FP208

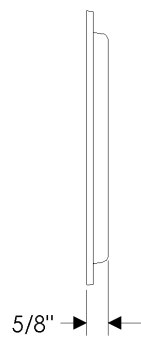
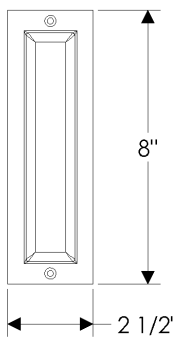

FP208 Flush Pull — Rectangular
 2 1/2" x 8" \$ 96.00



FP308

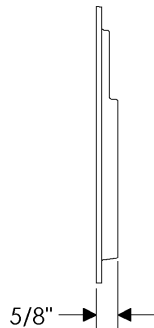
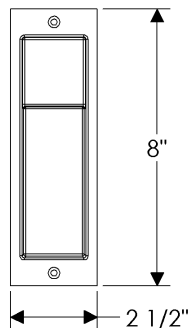

FP308 Flush Pull — Rectangular
 2 1/2" x 8" \$ 96.00

- All finishes are priced the same.
- Specify metal and patina.

Flush Pulls



FP258

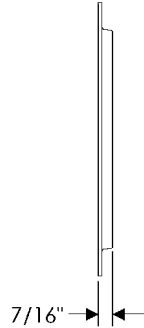
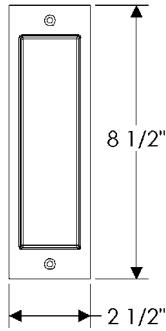

FP258 Flush Pull — Rectangular
 2 1/2" x 8 1/2" \$ 96.00



FP210

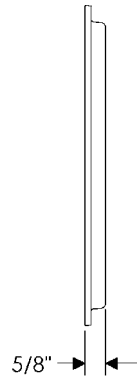
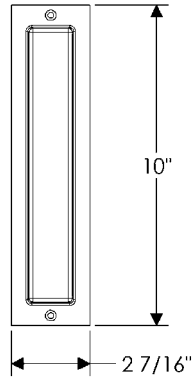

FP210 Flush Pull — Rectangular
 2 7/16" x 10" \$ 127.00

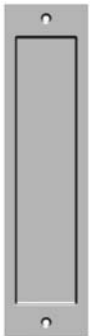

FP268

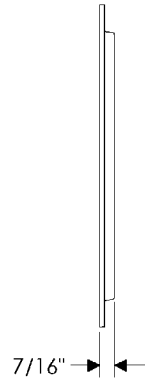
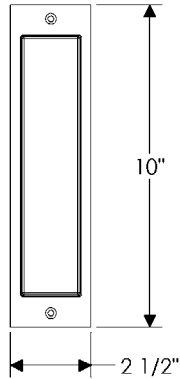

FP268 Flush Pull — Rectangular
 2 1/2" x 10" \$ 127.00

- All finishes are priced the same.
- Specify metal and patina.

Flush Pulls



FP260

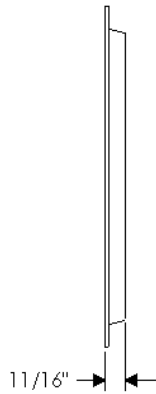
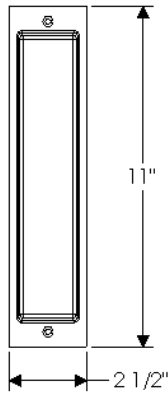

FP260 Flush Pull — Rectangular
 2 1/2" x 11" \$ 138.00

- **Note:** This will not work back-to-back on doors less than 1 1/2"

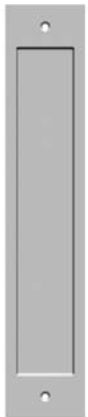

FP262

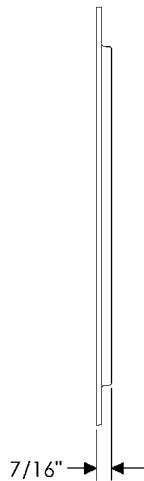
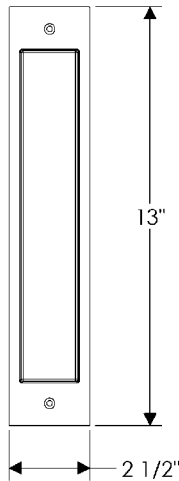

FP262 Flush Pull — Rectangular
 2 1/2" x 13" \$ 145.00

- All finishes are priced the same.
- Specify metal and patina.

Flush Pulls

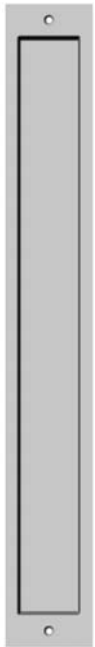

FP219

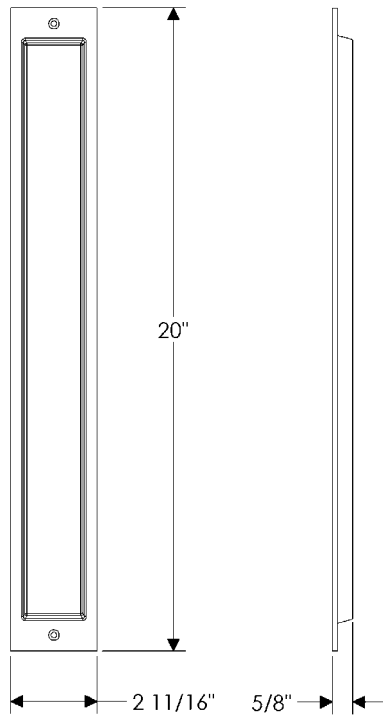

FP219 Flush Pull — Rectangular
 2 11/16" x 20" \$ 237.00



FP1349

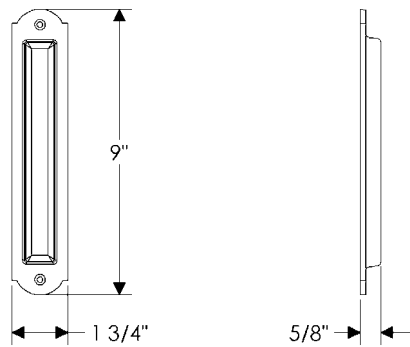

FP1349 Flush Pull — Arched
 1 3/4" x 9" \$ 102.00

- All finishes are priced the same.
- Specify metal and patina.

Flush Pulls

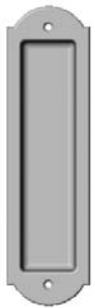

FP259

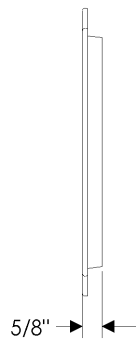
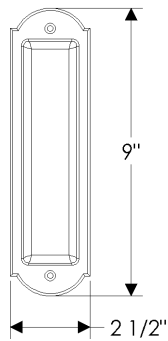

FP259 Flush Pull — Arched
 2 1/2" x 9" \$ 108.00



FP269

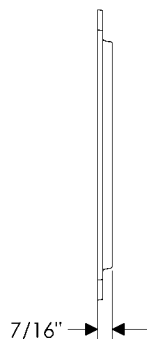
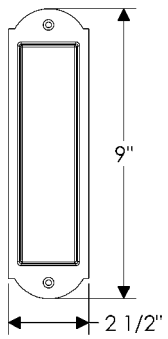

FP269 Flush Pull — Arched
 2 1/2" x 9" \$ 96.00



FP270

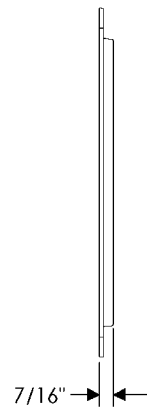
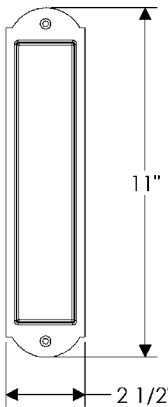

FP270 Flush Pull — Arched
 2 1/2" x 11" \$ 138.00

- All finishes are priced the same.
- Specify metal and patina.

Flush Pulls

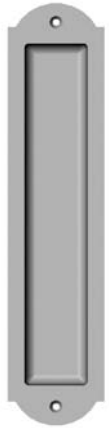

FP253

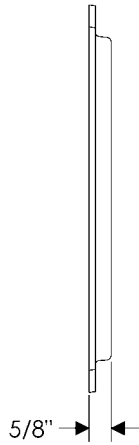
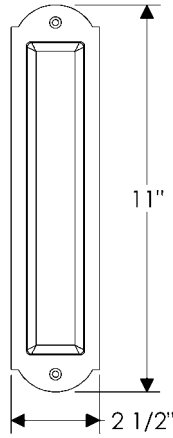

FP253 Flush Pull — Arched
 2 1/2" x 11" \$ 138.00

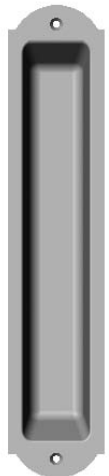

FP255

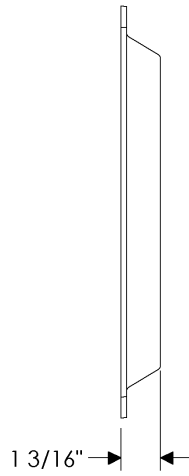
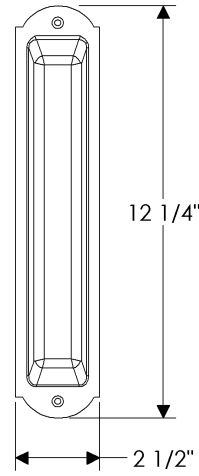

FP255 Flush Pull — Arched
 2 1/2" x 12 1/4" \$ 144.00

- **Note:** This will not work back-to-back on doors less than 2 1/2"



FP224

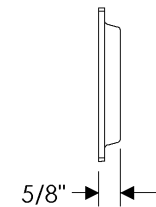
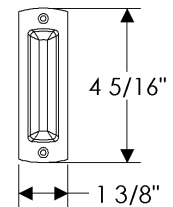

FP224 Flush Pull — Curved
 1 3/8" x 4 5/16" \$ 55.00

- All finishes are priced the same.
- Specify metal and patina.

Flush Pulls



FP249

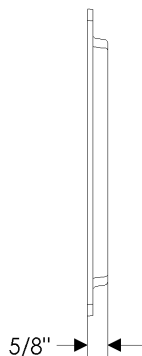
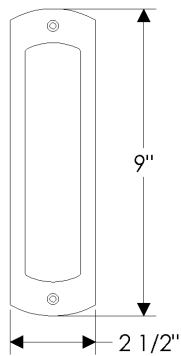

FP249 Flush Pull — Curved

2 1/2" x 9" \$ 108.00

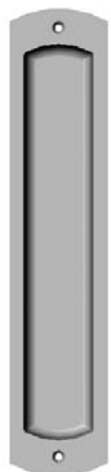

FP252

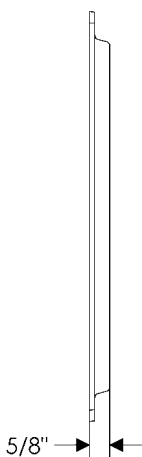
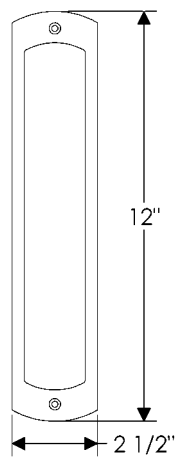

FP252 Flush Pull — Curved

2 1/2" x 12" \$ 142.00



FP512

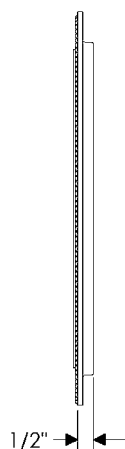
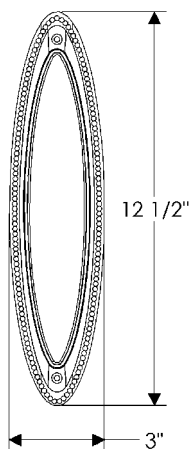

FP512 Flush Pull — Maddox

3" x 12 1/2" \$ 193.00

- All finishes are priced the same.
- Specify metal and patina.

Flush Pulls



FP025

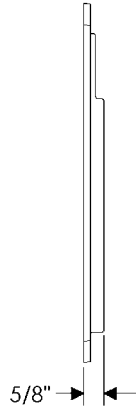
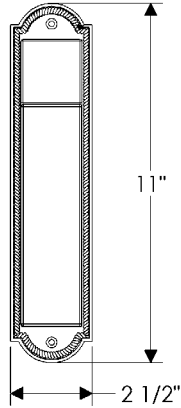

FP025 Flush Pull — Ellis

2 1/2" x 11" \$ 174.00



FP105

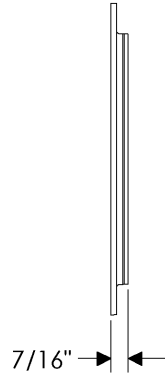
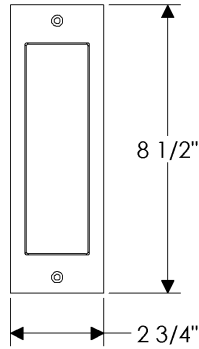

FP105 Flush Pull — Designer

2 3/4" x 8 1/2" \$ 311.00

- Requires leather or texture selection.

- All finishes are priced the same.
- Specify metal and patina.

Slide Fold

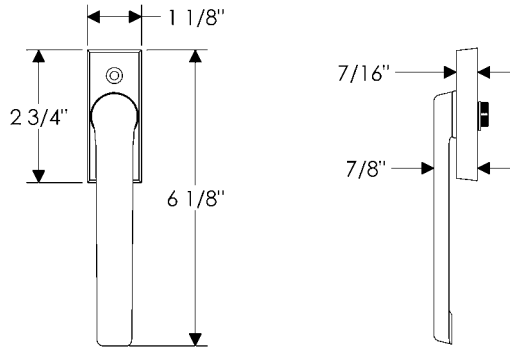
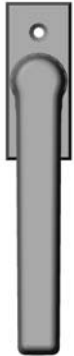

BF100 Slide Fold
 1 1/8" x 2 3/4" \$300.00

- Includes 7mm spindle.

Edge Pull

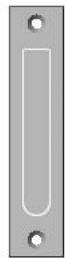

EP100

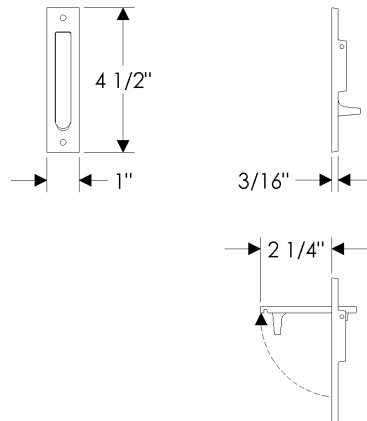

EP100 Edge Pull
 1" x 4 1/2" \$ 66.00

- All finishes are priced the same.
- Specify metal, patina, and door thickness.
- Backset limitations are 1 7/8"–3". (Note exceptions below).

PDL Pocket Door Lock

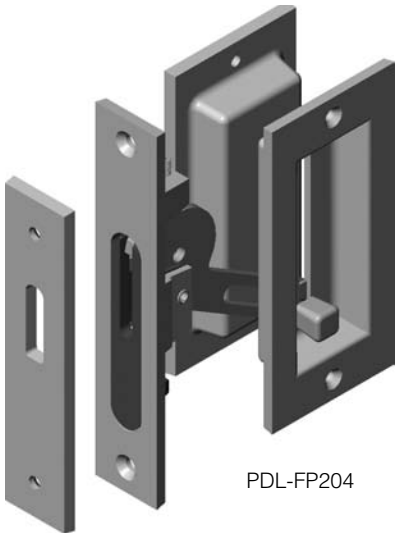

PDL-FP204

PDL Pocket Door Lock

with FP204 Flush Pull — Rectangular	
2" x 4 1/4"	\$ 327.00
with FP206 Flush Pull — Rectangular	
2 1/4" x 6"	\$ 368.00
with FP208 Flush Pull — Rectangular	
2 1/2" x 8"	\$ 409.00
with FP210 Flush Pull — Rectangular	
2 1/2" x 10"	\$ 472.00
with FP249 Flush Pull — Curved	
2 1/2" x 9"	\$ 434.00
with FP252 Flush Pull — Curved	
2 1/2" x 12"	\$ 502.00
with FP259 Flush Pull — Arched	
2 1/2" x 9"	\$ 434.00
with FP253 Flush Pull — Arched	
2 1/2" x 11"	\$ 495.00

- FP204 maximum backset 2 1/2"

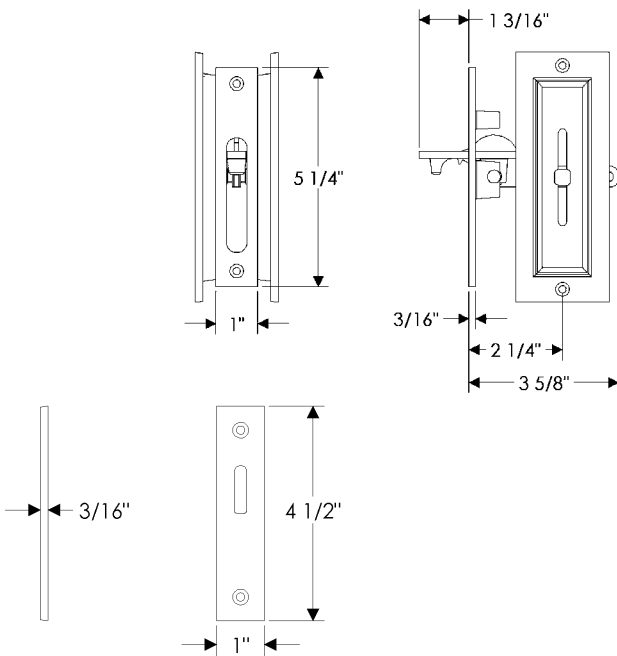

- All finishes are priced the same.
- Specify metal, patina, backset, and lock type.
- Available in 2 3/8" or 2 3/4" backsets.
- Works with door thicknesses of 1 3/4" or greater.
- Also available with FP025. Upcharge applies.

PDL Pocket Door Lock

EXTERIOR INTERIOR

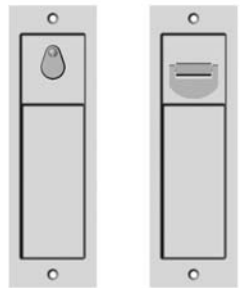

FP308

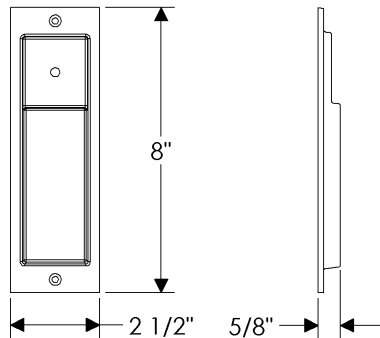

PDL Pocket Door Lock

FP308 2 1/2" x 8"

Privacy	\$ 635.00
Patio	\$ 605.00
Full Dummy	\$ 192.00
Refer to spec page I36	

- Included "Accurate 161PDL latch", "Accurate 161PDP" pocket door pull, and TP25 turn piece

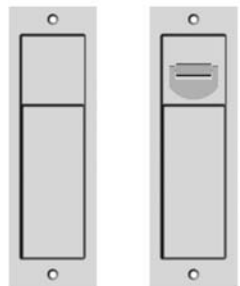

FP308

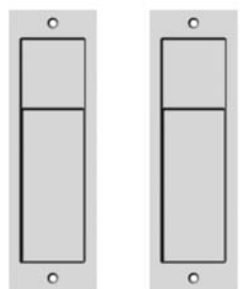
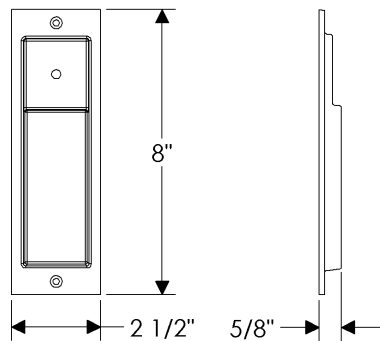

FP308

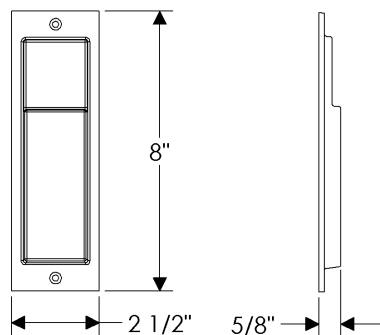

- All finishes are priced the same.
- Price includes FP258 Rectangular Flush Pull, as shown, or FP269 Arched Flush Pull. See page I36 or I39 for specifications.
- Specify metal, patina, backset, door thickness, and lock type.
- Prices are for 2 1/2" or 2 3/4" backsets. Additional charge for narrower and larger backsets (3 3/4", 5", or 6").
- Works with door thicknesses of 1 3/4" or greater.

SDL Sliding Door Lock — Patio Function

EXTERIOR INTERIOR

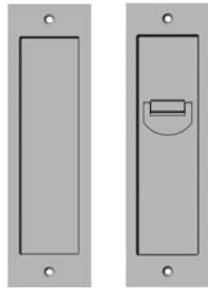

FP258 FP258

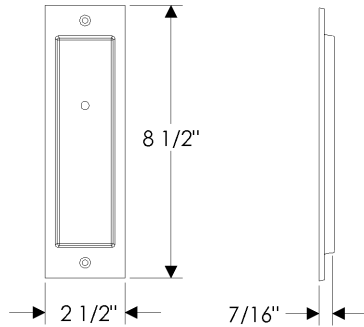

SDL-S-PO Sliding Door Lock

Patio Function \$ 501.00

- FP258 Rectangular Flush Pulls (2)
2 1/2" x 8 1/2"
- Includes "Accurate 2002 CPDL Lock/Pull" and TP25 turn piece

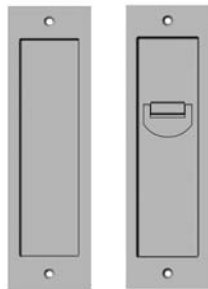

FP258 FP258

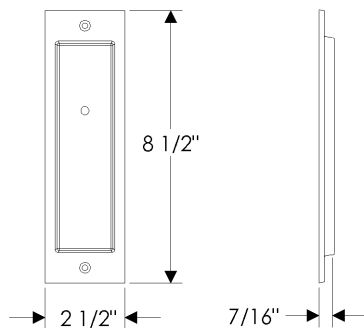

SDL-D-PO Sliding Door Lock

Double Door Patio Function \$ 913.00

- FP258 Rectangular Flush Pulls (4)
2 1/2" x 8 1/2"
- Includes "Accurate 2002 CPDL Lock/Pull, 2002 CPDS Strike/Pull" and TP25 turn piece

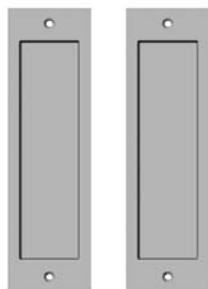

FP258 FP258

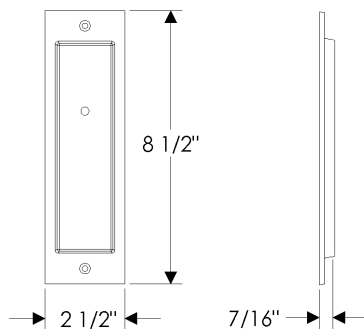

- All finishes are priced the same.
- Price includes FP258 Rectangular Flush Pull, as shown, or FP269 Arched Flush Pull. See page I36 or I39 for specifications.
- Specify metal, patina, backset, door thickness, and lock type.
- Prices are for 2 1/2" or 2 3/4" backsets. Additional charge for narrower and larger backsets (3 3/4", 5", or 6").
- Works with door thicknesses of 1 3/4" or greater.

SDL Sliding Door Lock — Privacy Function

EXTERIOR INTERIOR

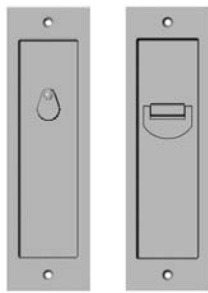

FP258 FP258

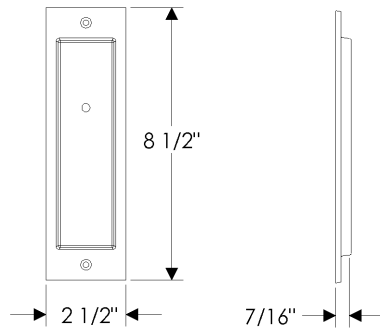

SDL-S-PR Sliding Door Lock

Privacy Function \$ 509.00

- FP258 Rectangular Flush Pulls (2)
2 1/2" x 8 1/2"
- Includes "Accurate 2002 CPDL Lock/Pull" and TP25 turn piece

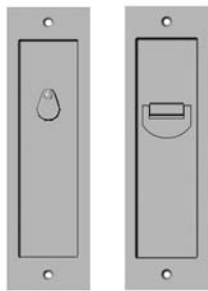

FP258 FP258

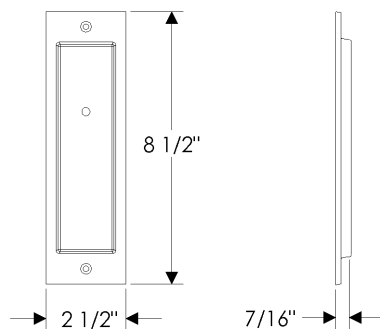

SDL-D-PR Sliding Door Lock

Double Door Privacy Function \$ 921.00

- FP258 Rectangular Flush Pulls (4)
2 1/2" x 8 1/2"
- Includes "Accurate 2002 CPDL Lock/Pull, 2002 CPDS Strike/Pull" and TP25 turn piece

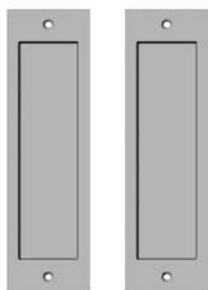

FP258 FP258

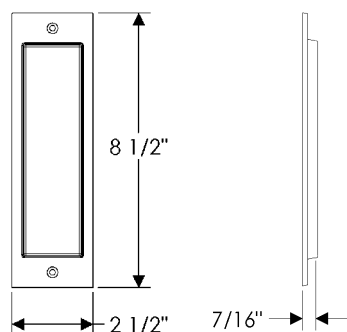

- All finishes are priced the same.
- Price includes FP258 Rectangular Flush Pull, as shown, or FP269 Arched Flush Pull. See page I36 of I39 for specifications.
- Specify metal, patina, backset, door thickness, and lock type.
- Prices are for 2 1/2" or 2 3/4" backsets. Additional charge for narrower and larger backsets (3 3/4", 5", or 6").
- Works with door thicknesses of 1 3/4" or greater.

SDL Sliding Door Lock — Entry Function

EXTERIOR INTERIOR

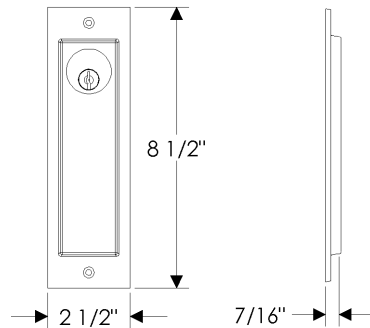
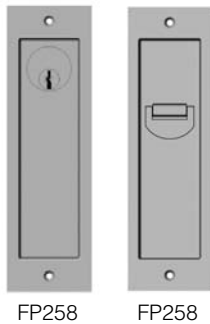

SDL-S-EN Sliding Door Lock
 Entry Function \$ 570.00

- FP258 Rectangular Flush Pulls (2)
 2 1/2" x 8 1/2"
- Includes "Accurate 2002 CPDL Lock/Pull", TP25 turn piece, and lock cylinder

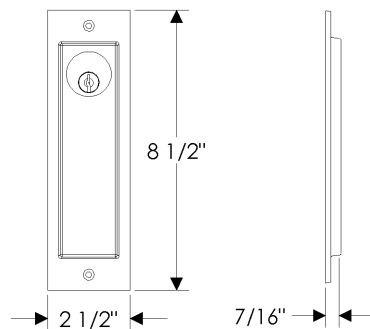
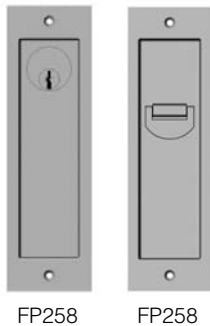

SDL-D-EN Sliding Door Lock
 Double Door Entry Function \$ 981.00

- FP258 Rectangular Flush Pulls (4)
 2 1/2" x 8 1/2"
- Includes "Accurate 2002 CPDL Lock/Pull", TP25 turn piece, and lock cylinder

