

Sample Order / Cheat Sheet
H Multi-Point Sets 1/3



HARDWARE WORK ORDER
 Toll Free 888.788.2013 or 208.788.2013; Fax 208.788.2577

QUOTE ORDER

ORDER DATE: _____
 CONTACT: _____
 JOB NAME: _____

NAME: _____
 ADDRESS: _____
 OFFICE PHONE: _____
 FAX PHONE: _____
 JOB PHONE: _____

PO# _____
 DELIVERY: _____
 ADDRESS: _____

2002.12.04

LINE NO.	FUNCTION	HANDLE		ESCUTCHEON		METAL	PATINA	HANDING OR LENGTH	BACKSET	DOOR THICKNESS	LOCK TYPE	DEAD BOLT TRIM	DESCRIPTION	LOCATION #	QTY.	PRICE QUOTED
		EXTERIOR	INTERIOR	EXTERIOR	INTERIOR											
1	EU-PO	L105	L105	E452	E458	B	L	R	2	134	AM		92mm	#25 A	1	555.00
2	EU-EN	L105	L105	E459	E458	B	L	L	2	134	AM		92mm	#35B	1	594.00
3	EU-EN	L117	L117	E748	E748	W	L	R	2	134	PR		85mm	#30	1	686.00
4	EU-PO	L117	L117	E746	E748	W	L	L	2	134	PR		85mm	#30	1	633.00
5	EU-DU	L117	L117	E746	E746	W	L	L						#31	1	474.00
6	EU-PA	L105	L105	E452	E452	B	L	R	2	134	AM			#25	1	519.00

FUNCTION

EU-DU = Dummy
 EU-EN = Multi-Point Entry
 EU-PA = Multi-Point Passage
 EU-PO = Multi-Point Patio

HANDLE

For a list of Levers available for Multi-Point Door Sets, see next page.
 For specifications, refer to Section A.

ESCUTCHEONS

For a list of Escutcheons available for Multi-Point Door Sets, see next page.
 For configurations, specifications, and pricing, refer to content of this section.

METAL

B = Silicon Bronze
 W = White Bronze

PATINA

L = Light
 M = Medium
 D = Dark
 R = Rust
 BB = Brushed

HANDING

See Hinged Door Handing diagram, next page.

L = Left Hand
 R = Right Hand
 LR = Left Hand Reverse
 RR = Right Hand Reverse

BACKSET

No lock mechanisms are provided with these sets.
 Backset information is needed to verify compatibility of trim with the existing door conditions.

DOOR THICKNESS

138 = 1 3/8"
 112 = 1 1/2"
 134 = 1 3/4"
 178 = 1 7/8"
 2 = 2"
 214 = 2 1/4"
 Up-charge for sizes below.
 Call for pricing.
 212 = 2 1/2"
 258 = 2 5/8"
 234 = 2 3/4"
 3 = 3"
 314 = 3 1/4"
 312 = 3 1/2"
 4 = 4"
 N = No

LOCK TYPE

AM = American Cylinder Lock
 PR = Profile Cylinder Lock

DEAD BOLT TRIM

Not Applicable

DESCRIPTION

Center to Center Dimension
 Lever to Cylinder

LOCATION #

Room Number or Door Number, etc.

QTY

Number of each desired

PRICE

\$ List price each

HANDLE**Levers**

L075 = Ellis Lever
 L101 = Longhorn Lever
 L102 = Squirrel Tail Lever
 L103 = Chub Lever
 L104 = Hook Lever
 L105 = Beaver Tail Lever
 L106 = Talon Lever
 L107 = Slugger Lever
 L108 = Tube Lever
 L109 = Legacy Lever
 L110 = Classic Lever
 L111 = Twig Lever
 L112 = Large Chub Lever
 L115 = Acanthus Lever
 L117 = French Lever
 L118 = French Twist Lever
 L119 = Long Legacy Lever
 L120 = Long French Lever
 L121 = Rock Creek Lever
 L122 = Large Hook Lever
 L123 = Old World Lever
 L125 = Classic Scroll Lever
 L126 = Triple Twist Lever
 L127 = Scroll Lever
 L128 = Small Classic Lever
 L130 = Monarch Lever
 L132 = Square Twist Lever
 L135 = Olympus Lever
 L137 = Olympus Return Lever
 L140 = Harrington Lever
 L141 = Large Rock Creek Lever
 L150 = Bella Lever
 L151 = Large Harrington Lever
 L153 = Talon Return Lever
 L158 = Large Acanthus Lever
 L160 = Wing Lever
 L163 = Euro Lever
 L174 = Lariat Lever
 L175 = Bamboo Lever
 L179 = Twig Return Lever
 L182 = Ribbon & Reed Lever
 L216 = Old World Return Lever
 L219 = Long Legacy Return Lever
 L224 = Ridge Lever
 L228 = Large Ridge Lever
 L241 = Large French Lever
 L245 = French Return Lever
 L276 = Falcon Lever
 L301 = Strap Lever
 L304 = Reed Lever

Levers (continued)

L307 = Jane Lever
 L310 = Pool Lever
 L314 = UJ Lever
 L580 = Maddox Lever
 L10010 = Paris Lever
 L10801 = Briggs Lever
 L10802 = Kettle Lever
 L21005 = Emile Lever

ESCUTCHEONS**Rectangular**

E456 = 1 3/8" x 11" Rect (LHi)
 E455 = 1 3/8" x 11" Rect (LHi)(PR)
 E481 = 1 3/8" x 11" Rect (LHi)(AM)
 E487 = 1 3/8" x 11" Rect (LHi)(TP)
 E489 = 1 3/8" x 11" Rect (LLO)
 E486 = 1 3/8" x 11" Rect (LLO)(AM)
 E488 = 1 3/8" x 11" Rect (LLO)(TP)
 E426 = 1 3/4" x 10" Rect (LLO)
 E425 = 1 3/4" x 10" Rect (LLO)(AM)
 E427 = 1 3/4" x 10" Rect (LLO)(TP)
 E446 = 1 3/4" x 11" Rect (LHi)
 E448 = 1 3/4" x 11" Rect (LHi)(PR)
 E445 = 1 3/4" x 11" Rect (LHi)(AM)
 E447 = 1 3/4" x 11" Rect (LHi)(TP)
 E441 = 1 3/4" x 11" Rect (LLO)
 E443 = 1 3/4" x 11" Rect (LLO)(AM)
 E442 = 1 3/4" x 11" Rect (LLO)(TP)
 E451 = 2 1/2" x 11" Rect (LHi)
 E457 = 2 1/2" x 11" Rect (LHi)(PR)
 E450 = 2 1/2" x 11" Rect (LHi)(AM)
 E453 = 2 1/2" x 11" Rect (LHi)(TP)
 E452 = 2 1/2" x 11" Rect (LLO)
 E459 = 2 1/2" x 11" Rect (LLO)(AM)
 E458 = 2 1/2" x 11" Rect (LLO)(TP)

Stepped

E376 = 1 3/8" x 11" Stepped (LHi)
 E375 = 1 3/8" x 11" Stepped (LHi)(PR)
 E377 = 1 3/8" x 11" Stepped (LHi)(TP)
 E327 = 1 3/8" x 11" Stepped (LLO)
 E328 = 1 3/8" x 11" Stepped (LLO)(TP)
 E330 = 1 3/4" x 11" Stepped (LHi)
 E332 = 1 3/4" x 11" Stepped (LHi)(PR)
 E338 = 1 3/4" x 11" Stepped (LHi)(AM)
 E336 = 1 3/4" x 11" Stepped (LHi)(TP)
 E331 = 1 3/4" x 11" Stepped (LLO)
 E339 = 1 3/4" x 11" Stepped (LLO)(AM)
 E337 = 1 3/4" x 11" Stepped (LLO)(TP)

Metro

E270 = 1 3/8" x 11" Metro (LHi)
 E274 = 1 3/8" x 11" Metro (LHi)(PR)
 E271 = 1 3/8" x 11" Metro (LHi)(TP)
 E272 = 1 3/8" x 11" Metro (LLO)
 E273 = 1 3/8" x 11" Metro (LLO)(TP)
 E241 = 1 3/4" x 11" Metro (LHi)
 E246 = 1 3/4" x 11" Metro (LHi)(PR)
 E245 = 1 3/4" x 11" Metro (LHi)(AM)
 E243 = 1 3/4" x 11" Metro (LHi)(TP)
 E240 = 1 3/4" x 11" Metro (LLO)
 E244 = 1 3/4" x 11" Metro (LLO)(AM)
 E242 = 1 3/4" x 11" Metro (LLO)(TP)

Ellis

E041 = 1 3/4" x 11" Ellis (LHi)
 E046 = 1 3/4" x 11" Ellis (LHi)(PR)
 E045 = 1 3/4" x 11" Ellis (LHi)(AM)
 E043 = 1 3/4" x 11" Ellis (LHi)(TP)
 E040 = 1 3/4" x 11" Ellis (LLO)
 E044 = 1 3/4" x 11" Ellis (LLO)(AM)
 E042 = 1 3/4" x 11" Ellis (LLO)(TP)

Arched

E718 = 1 3/8" x 11" Arched (LHi)
 E719 = 1 3/8" x 11" Arched (LHi)(PR)
 E776 = 1 3/4" x 10" Arched (LLO)
 E775 = 1 3/4" x 10" Arched (LLO)(AM)
 E777 = 1 3/4" x 10" Arched (LLO)(TP)
 E746 = 1 3/4" x 11" Arched (LHi)
 E748 = 1 3/4" x 11" Arched (LHi)(PR)
 E745 = 1 3/4" x 11" Arched (LHi)(AM)
 E747 = 1 3/4" x 11" Arched (LHi)(TP)
 E741 = 1 3/4" x 11" Arched (LLO)
 E743 = 1 3/4" x 11" Arched (LLO)(AM)
 E742 = 1 3/4" x 11" Arched (LLO)(TP)
 E751 = 2 1/2" x 11" Arched (LHi)
 E754 = 2 1/2" x 11" Arched (LHi)(PR)
 E750 = 2 1/2" x 11" Arched (LHi)(AM)
 E753 = 2 1/2" x 11" Arched (LHi)(TP)
 E755 = 2 1/2" x 11" Arched (LLO)
 E757 = 2 1/2" x 11" Arched (LLO)(AM)
 E756 = 2 1/2" x 11" Arched (LLO)(TP)

Curved

E576 = 1 3/8" x 11" Curved (LHi)
 E575 = 1 3/8" x 11" Curved (LHi)(PR)
 E577 = 1 3/8" x 11" Curved (LHi)(AM)
 E527 = 1 3/8" x 11" Curved (LLO)
 E528 = 1 3/8" x 11" Curved (LLO)(TP)
 E530 = 1 3/4" x 11" Curved (LHi)
 E532 = 1 3/4" x 11" Curved (LHi)(PR)

Curved (continued)

E538 = 1 3/4" x 11" Curved (LHi)(AM)
 E536 = 1 3/4" x 11" Curved (LHi)(TP)
 E531 = 1 3/4" x 11" Curved (LLO)
 E539 = 1 3/4" x 11" Curved (LLO)(AM)
 E537 = 1 3/4" x 11" Curved (LLO)(TP)

Fleur de Lis

E824 = 2" x 15" Fleur de Lis (LHi)
 E825 = 2" x 15" Fleur de Lis (LHi)(PR)
 E826 = 2" x 15" Fleur de Lis (LHi)(AM)
 E827 = 2" x 15" Fleur de Lis (LHi)(TP)
 E817 = 2" x 15" Fleur de Lis (LLO)
 E819 = 2" x 15" Fleur de Lis (LLO)(AM)
 E818 = 2" x 15" Fleur de Lis (LLO)(TP)

Maddox

E591 = 1 3/4" x 11" Maddox (LHi)
 E592 = 1 3/4" x 11" Maddox (LHi)(PR)
 E595 = 1 3/4" x 11" Maddox (LHi)(AM)
 E597 = 1 3/4" x 11" Maddox (LHi)(TP)
 E590 = 1 3/4" x 11" Maddox (LLO)
 E594 = 1 3/4" x 11" Maddox (LLO)(AM)
 E596 = 1 3/4" x 11" Maddox (LLO)(TP)

Briggs

E10871 = 2" x 15" Briggs (LHi)
 E10873 = 2" x 15" Briggs (LHi)(PR)
 E10870 = 2" x 15" Briggs (LHi)(AM)
 E10872 = 2" x 15" Briggs (LHi)(TP)
 E10874 = 2" x 15" Briggs (LLO)
 E10875 = 2" x 15" Briggs (LLO)(AM)
 E10876 = 2" x 15" Briggs (LLO)(TP)

Mack

E21041 = 1 3/4" x 11" Mack (LHi)
 E21046 = 1 3/4" x 11" Mack (LHi)(PR)
 E21045 = 1 3/4" x 11" Mack (LHi)(AM)
 E21043 = 1 3/4" x 11" Mack (LHi)(TP)
 E21040 = 1 3/4" x 11" Mack (LLO)
 E21044 = 1 3/4" x 11" Mack (LLO)(AM)
 E21042 = 1 3/4" x 11" Mack (LLO)(TP)

Key

(LHi) = Lever High
 (LLO) = Lever Low
 (AM) = American Cylinder Escutcheon
 (PR) = Profile Cylinder Escutcheon
 (TP) = Turn Piece Escutcheon

Note: Designer line utilizes Metro Series plates for Multi-point.

Handing

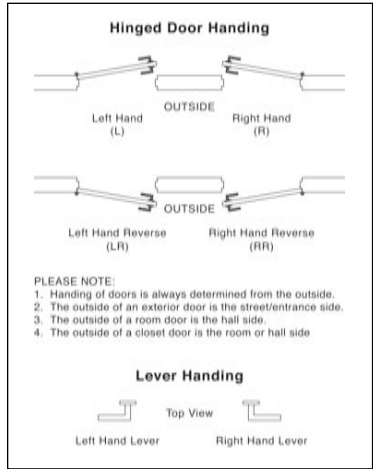

Multi-Point Profile Cylinder Set—Lever to Lever

- 1 Lever
- 2 Escutcheon
- 3 8mm Straight Spindle
- 4 Profile Cylinder
- 5 Turn Piece
- 6 Cylinder Set Screw

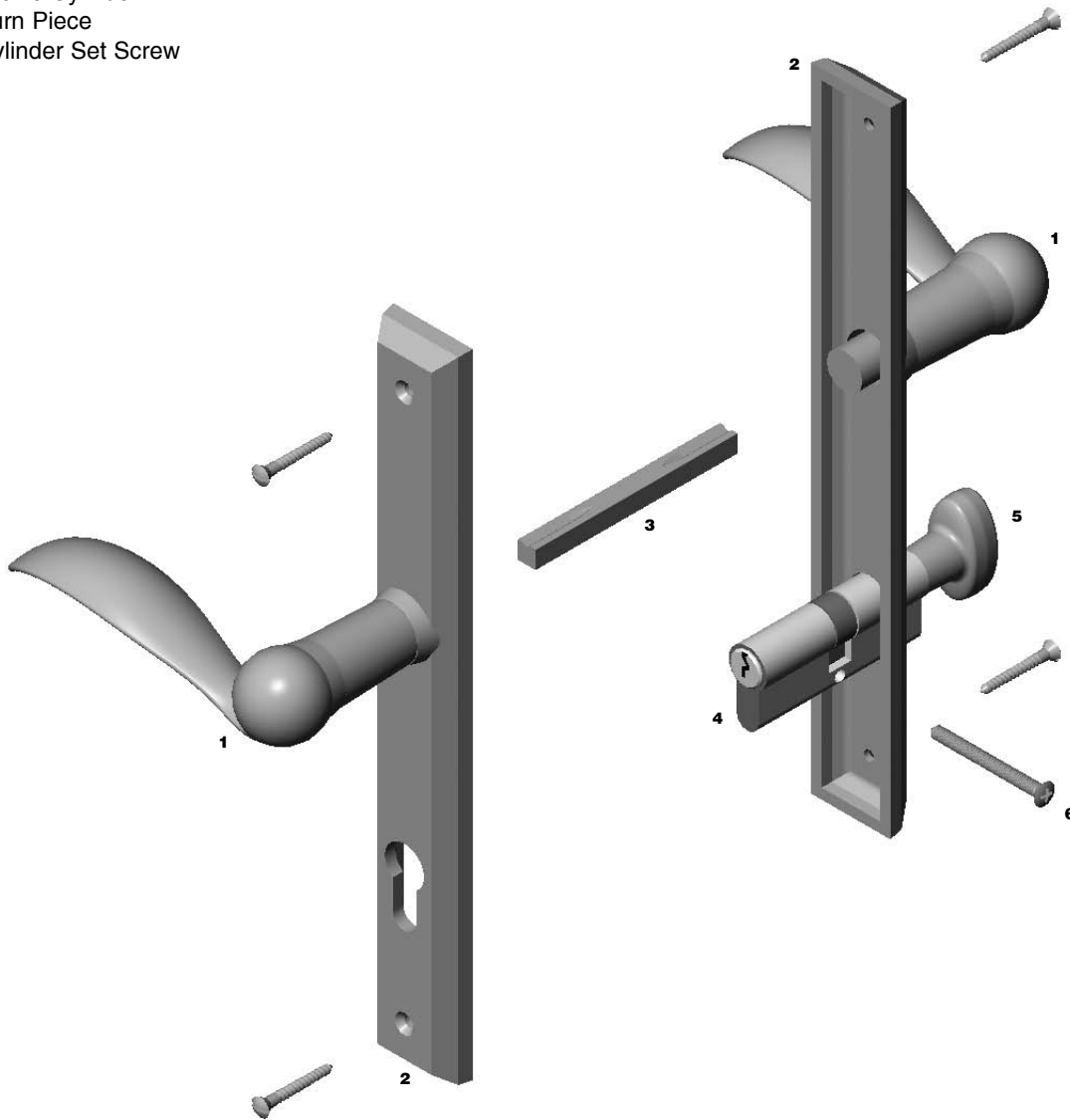

Multi Point Door Information

- 1. Manufacture _____ (Pella, Marvin, etc.)
- 2. Function _____ (Patio, Entry, or Dummy)
- 3. Stile Width _____ (Inches)
- 4. Back Set _____ (Inches)
- 6. Door thickness A: _____
- 7. Lock Offset B: _____ C: _____
- 8. Mounting hole location from turn piece.
 - a. Use existing mounting holes? Yes No
 - b. Use sexbolts? Yes No
- 9. Escutcheon
 - a. Type _____ (Example: Arched)
 - b. Size _____ (Height x Width)
- 10. Lever _____ (Example: L130)
- 11. American Cylinder or Profile Cylinder? _____

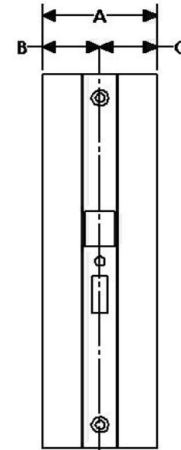

Examples of cut in lock body:



- 12. Hardware projection limitations? _____ (i.e. for screen door)
- 13. Handing? _____ (From Exterior) (L, R,LR,RR)
- 14. Lever High or Low? _____
- 15. French Door Opening, Active or Fixed Levers? _____
- 16. Further information/hand sketches _____

Notes:

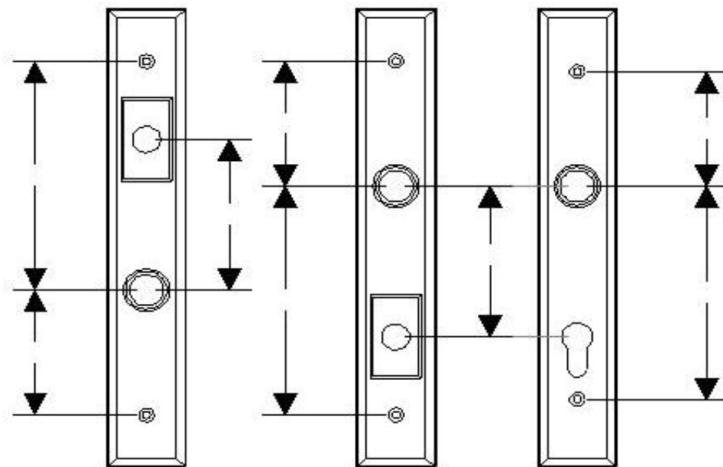





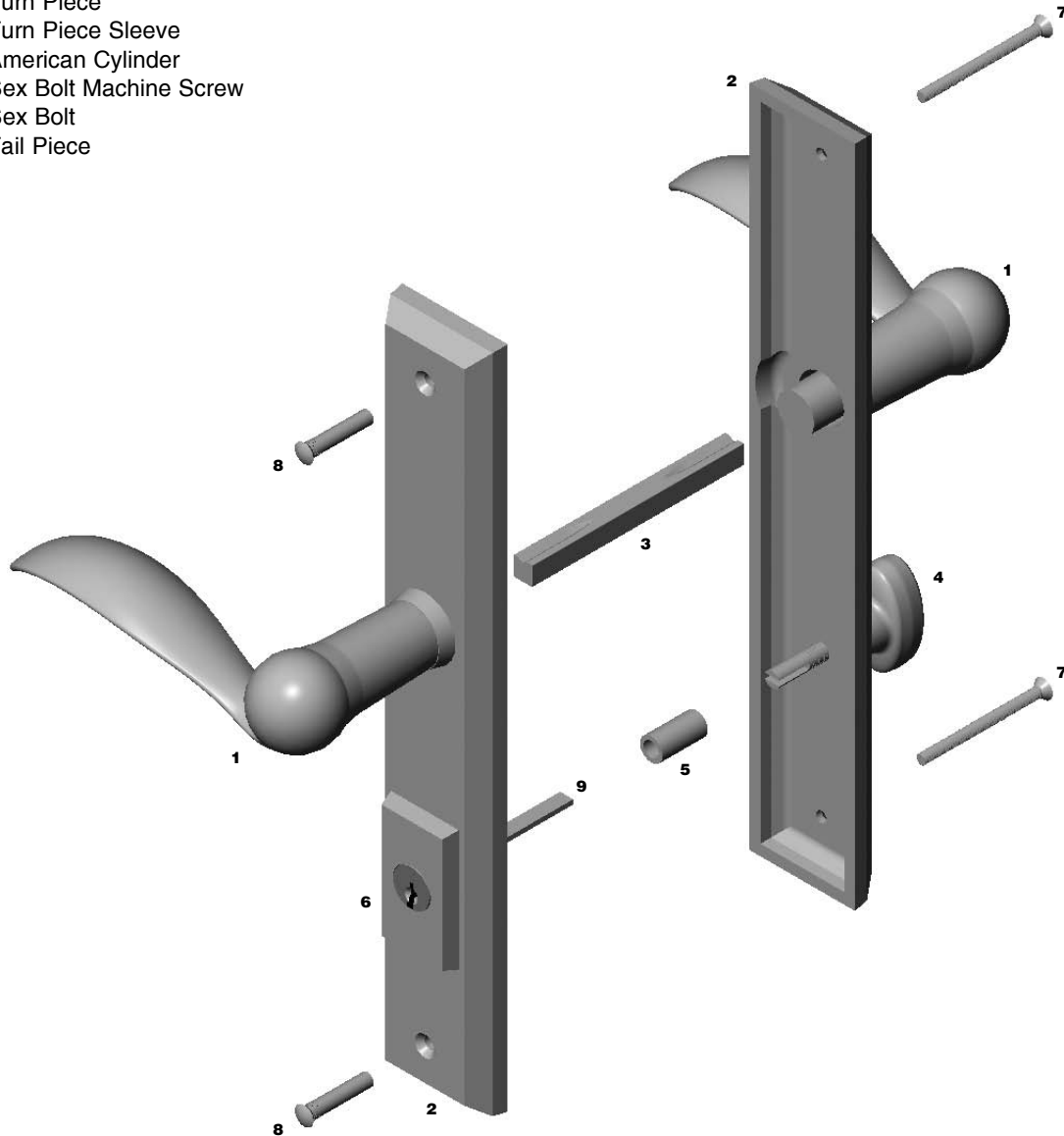

PLEASE PROVIDE DIMENSIONS

Multi-Point American Cylinder Set—Lever to Lever

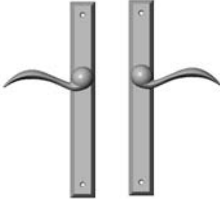
- 1 Lever
- 2 Escutcheon
- 3 8mm Straight Spindle
- 4 Turn Piece
- 5 Turn Piece Sleeve
- 6 American Cylinder
- 7 Sex Bolt Machine Screw
- 8 Sex Bolt
- 9 Tail Piece

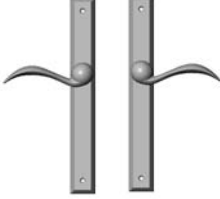

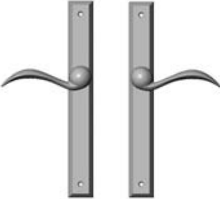
- All finishes are priced the same.
- Price includes your choice of handle except for the Crystal Knobs (K150 and K155), where an upcharge applies. (Knobs and rings are not recommended for multi-point combinations.) Call RMH for pricing.
- Combinations are shown with L105 Beaver Tail Lever for illustrations purposes only. Refer to Section A for desired lever.
- Entry, Patio, and Passage functions include 8mm spindle.
- Specify metal, patina, handing, backset, door thickness, lock type, and center-to-center dimension.

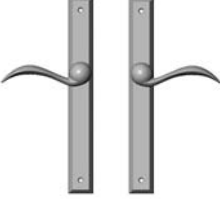
ACTIVE	DUMMY	ESCUTCHEON OPTIONS
<p>A</p>  <p>E455 E455</p>	 <p>E456 E456</p>	<p>A 1 3/8" x 11" Rectangular Escutcheon Profile Cylinder E455 / E455 Entry Trim* \$665.00 E456 / E455 Patio Trim* \$612.00 E456 / E456 Full Dummy \$453.00</p> <ul style="list-style-type: none"> • Entry Trim includes Profile cylinder and turn piece. • Patio Trim includes 1/2 Profile cylinder and turn piece. <p>Refer to spec page B7</p>
 <p>E456 E455</p>	 <p>E456 E456</p>	<p>B 1 3/8" x 11" Rectangular Escutcheon American Cylinder E481 / E487 Entry Trim* \$572.00 E456 / E487 Patio Trim* \$532.00 E456 / E456 Passage Trim \$487.00 E456 / E456 Full Dummy \$453.00</p> <ul style="list-style-type: none"> • Entry Trim includes American cylinder and turn piece. • Patio Trim includes turn piece. <p>Refer to spec page B7</p>
<p>B</p>  <p>E481 E487</p>	 <p>E456 E456</p>	<p>* The center to center dimension will need to be verified before set can be ordered.</p>
 <p>E456 E487</p>	 <p>E456 E456</p>	

- All finishes are priced the same.
- Price includes your choice of handle except for the Crystal Knobs (K150 and K155), where an upcharge applies. (Knobs and rings are not recommended for multi-point combinations.) Call RMH for pricing.
- Combinations are shown with L105 Beaver Tail Lever for illustrations purposes only. Refer to Section A for desired lever.
- Entry, Patio, and Passage functions include 8mm spindle.
- Specify metal, patina, handing, backset, door thickness, lock type, and center-to-center dimension.

ACTIVE

DUMMY

ESCUTCHEON OPTIONS

A

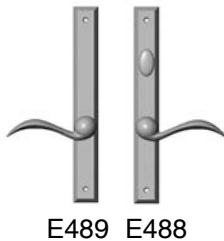
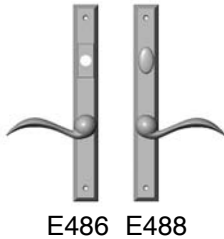

B

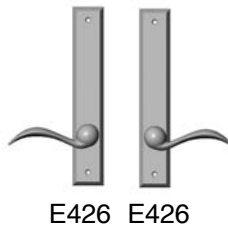
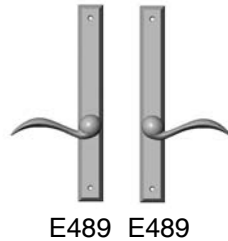
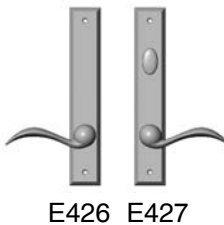

**A 1 3/8" x 11" Rectangular Escutcheon
American Cylinder**

E486 / E488 Entry Trim*	\$572.00
E489 / E488 Patio Trim*	\$532.00
E489 / E489 Passage Trim	\$487.00
E489 / E489 Full Dummy	\$453.00

- Entry Trim includes American cylinder and turn piece.
 - Patio Trim includes turn piece.
- Refer to spec page B7







**B 1 3/4" x 10" Rectangular Escutcheon (105 mm c-to-c)
American Cylinder**

E425 / E427 Entry Trim*	\$594.00
E426 / E427 Patio Trim*	\$555.00
E426 / E426 Passage Trim	\$519.00
E426 / E426 Full Dummy	\$474.00

- Entry Trim includes American cylinder and turn piece.
 - Patio Trim includes turn piece.
- Refer to spec page B8

* The center to center dimension will need to be verified before set can be ordered.

- All finishes are priced the same.
- Price includes your choice of handle except for the Crystal Knobs (K150 and K155), where an upcharge applies. (Knobs and rings are not recommended for multi-point combinations.) Call RMH for pricing.
- Combinations are shown with L105 Beaver Tail Lever for illustrations purposes only. Refer to Section A for desired lever.
- Entry, Patio, and Passage functions include 8mm spindle.
- Specify metal, patina, handing, backset, door thickness, lock type, and center-to-center dimension.

	ACTIVE	DUMMY	ESCUTCHEON OPTIONS
A	 <p>E448 E448</p>  <p>E446 E448</p>	 <p>E446 E446</p>	<p>A 1 3/4" x 11" Rectangular Escutcheon Profile Cylinder</p> <p>E448 / E448 Entry Trim* \$ 686.00 E446 / E448 Patio Trim*..... \$ 633.00 E446 / E446 Full Dummy \$ 474.00</p> <ul style="list-style-type: none"> • Entry Trim includes Profile cylinder and turn piece. • Patio Trim includes 1/2 Profile cylinder and turn piece. <p>Refer to spec page B8</p>
B	 <p>E445 E447</p>  <p>E446 E447</p>	 <p>E446 E446</p>	<p>B 1 3/4" x 11" Rectangular Escutcheon American Cylinder</p> <p>E445 / E447 Entry Trim* \$ 594.00 E446 / E447 Patio Trim*..... \$ 555.00 E446 / E446 Passage Trim \$ 519.00 E446 / E446 Full Dummy \$ 474.00</p> <ul style="list-style-type: none"> • Entry Trim includes American cylinder and turn piece. • Patio Trim includes turn piece. <p>Refer to spec page B8</p> <p>* The center to center dimension will need to be verified before set can be ordered.</p>

- All finishes are priced the same.
- Price includes your choice of handle except for the Crystal Knobs (K150 and K155), where an upcharge applies. (Knobs and rings are not recommended for multi-point combinations.) Call RMH for pricing.
- Combinations are shown with L105 Beaver Tail Lever for illustrations purposes only. Refer to Section A for desired lever.
- Entry, Patio, and Passage functions include 8mm spindle.
- Specify metal, patina, handing, backset, door thickness, lock type, and center-to-center dimension.

ACTIVE

DUMMY

ESCUTCHEON OPTIONS

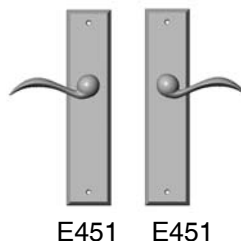
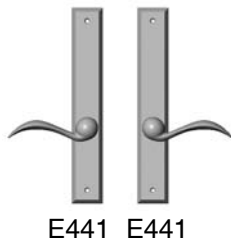
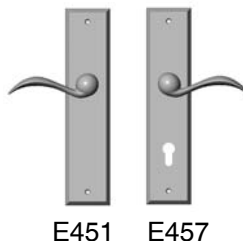
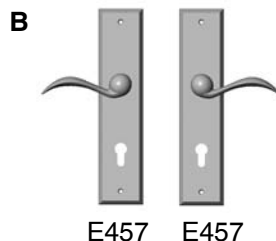
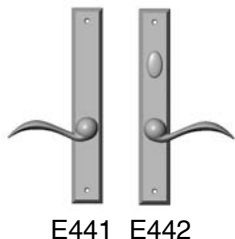
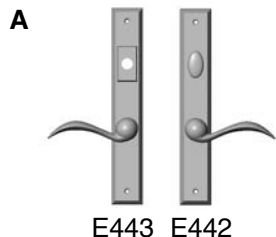

A 1 3/4" x 11" Rectangular Escutcheon American Cylinder

- E443 / E442 Entry Trim* \$594.00
- E441 / E442 Patio Trim*..... \$555.00
- E441 / E441 Passage Trim \$519.00
- E441 / E441 Full Dummy..... \$474.00

- Entry Trim includes American cylinder and turn piece.
- Patio Trim includes turn piece.
- Refer to spec page B8





B 2 1/2" x 11" Rectangular Escutcheon Profile Cylinder

- E457 / E457 Entry Trim* \$686.00
- E451 / E457 Patio Trim*..... \$633.00
- E451 / E451 Full Dummy..... \$474.00





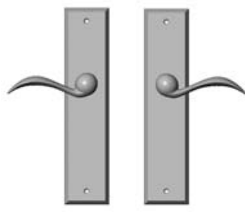

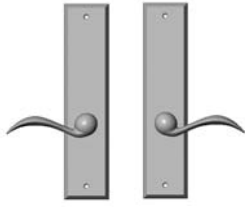
- Entry Trim includes Profile cylinder and turn piece.
- Patio Trim includes 1/2 Profile cylinder and turn piece.
- Refer to spec page B9

* The center to center dimension will need to be verified before set can be ordered.

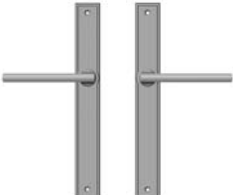

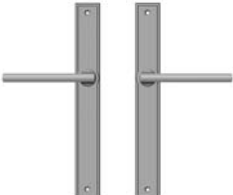

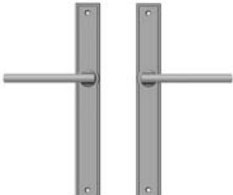
- All finishes are priced the same.
- Price includes your choice of handle except for the Crystal Knobs (K150 and K155), where an upcharge applies. (Knobs and rings are not recommended for multi-point combinations.) Call RMH for pricing.
- Combinations are shown with L105 Beaver Tail Lever for illustrations purposes only. Refer to Section A for desired lever.
- Entry, Patio, and Passage functions include 8mm spindle.
- Specify metal, patina, handing, backset, door thickness, lock type, and center-to-center dimension.

	ACTIVE	DUMMY	ESCUTCHEON OPTIONS
A	 <p>E450 E453</p>  <p>E451 E453</p>	 <p>E451 E451</p>	<p>A 2 1/2" x 11" Rectangular Escutcheon American Cylinder</p> <p>E450 / E453 Entry Trim* \$ 594.00 E451 / E453 Patio Trim* \$ 555.00 E451 / E451 Passage Trim \$ 519.00 E451 / E451 Full Dummy \$ 474.00</p> <ul style="list-style-type: none"> • Entry Trim includes American cylinder and turn piece. • Patio Trim includes turn piece. <p>Refer to spec page B9</p> <p>B 2 1/2" x 11" Rectangular Escutcheon American Cylinder</p> <p>E459 / E458 Entry Trim* \$ 594.00 E452 / E458 Patio Trim* \$ 555.00 E452 / E452 Passage Trim \$ 519.00 E452 / E452 Full Dummy \$ 474.00</p> <ul style="list-style-type: none"> • Entry Trim includes American cylinder and turn piece. • Patio Trim includes turn piece. <p>Refer to spec page B9</p> <p>* The center to center dimension will need to be verified before set can be ordered.</p>
B	 <p>E459 E458</p>  <p>E452 E458</p>	 <p>E452 E452</p>	

- All finishes are priced the same.
- Price includes your choice of handle except for the Crystal Knobs (K150 and K155), where an upcharge applies. (Knobs and rings are not recommended for multi-point combinations.) Call RMH for pricing.
- Combinations are shown with L135 Olympus Lever for illustrations purposes only. Refer to Section A for desired lever.
- Entry, Patio, and Passage functions include 8mm spindle.
- Specify metal, patina, handing, backset, door thickness, lock type, and center-to-center dimension.

ACTIVE	DUMMY	ESCUTCHEON OPTIONS
<p>A</p>  <p>E375 E375</p>	 <p>E376 E376</p>	<p>A 1 3/8" x 11" Stepped Escutcheon Profile Cylinder</p> <p>E375 / E375 Entry Trim* \$665.00 E376 / E375 Patio Trim* \$612.00 E376 / E376 Full Dummy \$453.00</p> <ul style="list-style-type: none"> • Entry Trim includes Profile cylinder and turn piece. • Patio Trim includes 1/2 Profile cylinder and turn piece. <p>Refer to spec page B19</p>
 <p>E376 E375</p>	 <p>E376 E376</p>	<p>B 1 3/8" x 11" Stepped Escutcheon American Cylinder</p> <p>E376 / E377 Patio Trim* \$532.00 E376 / E376 Passage Trim \$487.00 E376 / E376 Full Dummy \$453.00</p> <ul style="list-style-type: none"> • Patio Trim includes turn piece. <p>Refer to spec page B19</p>
<p>B</p>  <p>E376 E377</p>	 <p>E376 E376</p>	<p>C 1 3/8" x 11" Stepped Escutcheon American Cylinder</p> <p>E327 / E328 Patio Trim* \$532.00 E327 / E327 Passage Trim \$487.00 E327 / E327 Full Dummy \$453.00</p> <ul style="list-style-type: none"> • Patio Trim includes turn piece. <p>Refer to spec page B19</p>
<p>C</p>  <p>E327 E328</p>	 <p>E327 E327</p>	<p>* The center to center dimension will need to be verified before set can be ordered.</p>

- All finishes are priced the same.
- Price includes your choice of handle except for the Crystal Knobs (K150 and K155), where an upcharge applies. (Knobs and rings are not recommended for multi-point combinations.) Call RMH for pricing.
- Combinations are shown with L135 Olympus Lever for illustrations purposes only. Refer to Section A for desired lever.
- Entry, Patio, and Passage functions include 8mm spindle.
- Specify metal, patina, handing, backset, door thickness, lock type, and center-to-center dimension.

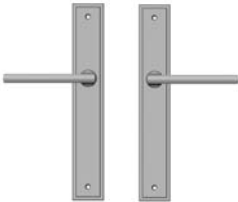
ACTIVE	DUMMY	ESCUTCHEON OPTIONS
<p>A</p>  <p>E332 E332</p>		<p>A 1 3/4" x 11" Stepped Escutcheon Profile Cylinder</p> <p>E332 / E332 Entry Trim* \$686.00 E330 / E332 Patio Trim*..... \$633.00 E330 / E330 Full Dummy \$474.00</p> <ul style="list-style-type: none"> • Entry Trim includes Profile cylinder and turn piece. • Patio Trim includes 1/2 Profile cylinder and turn piece. <p>Refer to spec page B19</p>
 <p>E330 E332</p>	 <p>E330 E330</p>	<p>B 1 3/4" x 11" Stepped Escutcheon American Cylinder</p> <p>E338 / E336 Entry Trim* \$594.00 E330 / E336 Patio Trim*..... \$555.00 E330 / E330 Passage Trim \$519.00 E330 / E330 Full Dummy \$474.00</p> <ul style="list-style-type: none"> • Entry Trim includes American cylinder and turn piece. • Patio Trim includes turn piece. <p>Refer to spec page B19</p>
<p>B</p>  <p>E338 E336</p>		<p>* The center to center dimension will need to be verified before set can be ordered.</p>
 <p>E330 E336</p>	 <p>E330 E330</p>	

- All finishes are priced the same.
- Price includes your choice of handle except for the Crystal Knobs (K150 and K155), where an upcharge applies. (Knobs and rings are not recommended for multi-point combinations.) Call RMH for pricing.
- Combinations are shown with L135 Olympus Lever for illustrations purposes only. Refer to Section A for desired lever.
- Entry, Patio, and Passage functions include 8mm spindle.
- Specify metal, patina, handing, backset, door thickness, lock type, and center-to-center dimension.

ACTIVE

DUMMY

ESCUTCHEON OPTIONS

A



E339 E337



E331 E337



E331 E331





**A 1 3/4" x 11" Stepped Escutcheon
American Cylinder**

E339 / E337 Entry Trim*	\$ 594.00
E331 / E337 Patio Trim*	\$ 555.00
E331 / E331 Passage Trim	\$ 519.00
E331 / E331 Full Dummy	\$ 474.00

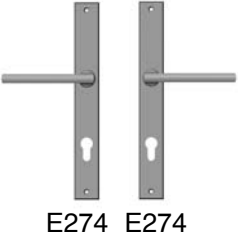
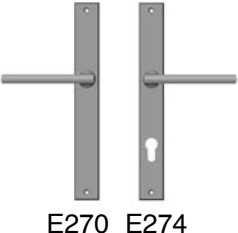
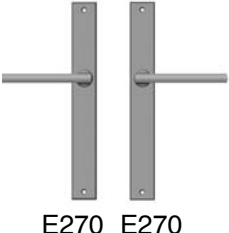

- Entry Trim includes American cylinder and turn piece.
 - Patio Trim includes turn piece.
- Refer to spec page B19

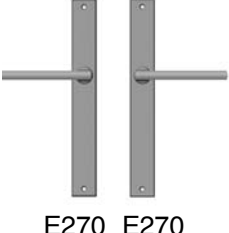
* The center to center dimension will need to be verified before set can be ordered.

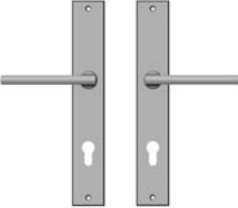

- All finishes are priced the same.
- Price includes your choice of handle except for the Crystal Knobs (K150 and K155), where an upcharge applies. (Knobs and rings are not recommended for multi-point combinations.) Call RMH for pricing.
- Combinations are shown with L135 Olympus Lever for illustrations purposes only. Refer to Section A for desired lever.
- Entry, Patio, and Passage functions include 8mm spindle.
- Specify metal, patina, handing, backset, door thickness, lock type, and center-to-center dimension.

	ACTIVE	DUMMY	ESCUTCHEON OPTIONS	
A	 <p>E274 E274</p>		<p>A 1 3/8" x 11" Metro Escutcheon Profile Cylinder E274 / E274 Entry Trim* \$665.00 E270 / E274 Patio Trim* \$612.00 E270 / E270 Full Dummy \$453.00</p> <ul style="list-style-type: none"> • Entry Trim includes Profile cylinder and turn piece. • Patio Trim includes 1/2 Profile cylinder and turn piece. <p>Refer to spec page B30</p>	
	 <p>E270 E274</p>	 <p>E270 E270</p>		
B	 <p>E270 E271</p>	 <p>E270 E270</p>		<p>B 1 3/8" x 11" Metro Escutcheon American Cylinder E270 / E271 Patio Trim* \$532.00 E270 / E270 Passage Trim \$487.00 E270 / E270 Full Dummy \$453.00</p> <ul style="list-style-type: none"> • Patio Trim includes turn piece. <p>Refer to spec page B30</p>
C	 <p>E272 E273</p>	 <p>E272 E272</p>		
			<p>* The center to center dimension will need to be verified before set can be ordered.</p>	

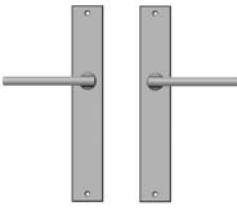
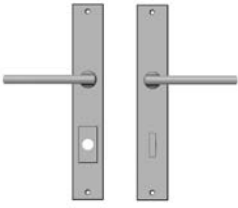
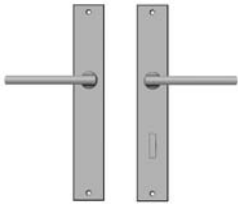
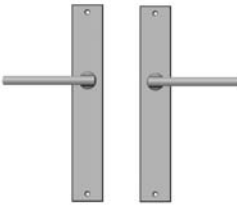

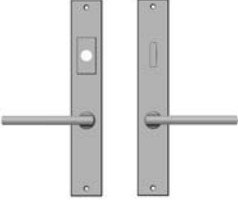

- All finishes are priced the same.
- Price includes your choice of handle except for the Crystal Knobs (K150 and K155), where an upcharge applies. (Knobs and rings are not recommended for multi-point combinations.) Call RMH for pricing.
- Combinations are shown with L135 Olympus Lever for illustrations purposes only. Refer to Section A for desired lever.
- Entry, Patio, and Passage functions include 8mm spindle.
- Specify metal, patina, handing, backset, door thickness, lock type, and center-to-center dimension.

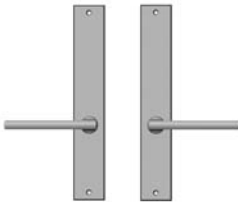
ACTIVE	DUMMY	ESCUTCHEON OPTIONS
<p>A</p>  <p>E246 E246</p>		<p>A 1 3/4" x 11" Metro Escutcheon Profile Cylinder</p> <p>E246 / E246 Entry Trim* \$686.00 E241 / E246 Patio Trim* \$633.00 E241 / E241 Full Dummy \$474.00</p> <ul style="list-style-type: none"> • Entry Trim includes Profile cylinder and turn piece. • Patio Trim includes 1/2 Profile cylinder and turn piece. <p>Refer to spec page B30</p>
 <p>E241 E246</p>	 <p>E241 E241</p>	<p>B 1 3/4" x 11" Metro Escutcheon American Cylinder</p> <p>E245 / E243 Entry Trim* \$594.00 E241 / E243 Patio Trim* \$555.00 E241 / E241 Passage Trim \$519.00 E241 / E241 Full Dummy \$474.00</p> <ul style="list-style-type: none"> • Entry Trim includes American cylinder and turn piece. • Patio Trim includes turn piece. <p>Refer to spec page B30</p>
<p>B</p>  <p>E245 E243</p>		<p>* The center to center dimension will need to be verified before set can be ordered.</p>
 <p>E241 E243</p>	 <p>E241 E241</p>	

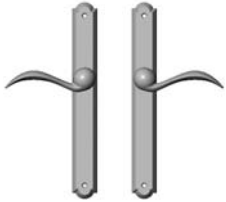

- All finishes are priced the same.
- Price includes your choice of handle except for the Crystal Knobs (K150 and K155), where an upcharge applies. (Knobs and rings are not recommended for multi-point combinations.) Call RMH for pricing.
- Combinations are shown with L135 Olympus Lever for illustrations purposes only. Refer to Section A for desired lever.
- Entry, Patio, and Passage functions include 8mm spindle.
- Specify metal, patina, handing, backset, door thickness, lock type, and center-to-center dimension.

ACTIVE	DUMMY	ESCUTCHEON OPTIONS
<p>A</p>  <p>E244 E242</p>  <p>E240 E242</p>	 <p>E240 E240</p>	<p>A 1 3/4" x 11" Metro Escutcheon</p> <p>American Cylinder</p> <p>E244 / E242 Entry Trim* \$594.00</p> <p>E240 / E242 Patio Trim*..... \$555.00</p> <p>E240 / E240 Passage Trim \$519.00</p> <p>E240 / E240 Full Dummy \$474.00</p> <ul style="list-style-type: none"> • Entry Trim includes American cylinder and turn piece. • Patio Trim includes turn piece. <p>Refer to spec page B30</p> <p>* The center to center dimension will need to be verified before set can be ordered.</p>

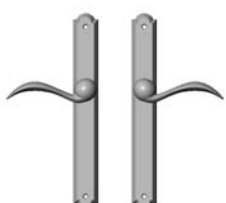
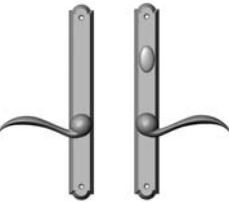
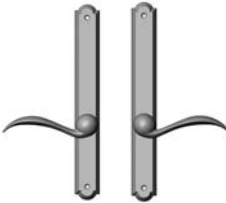

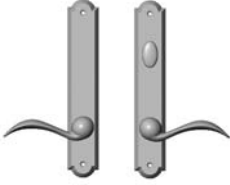

- All finishes are priced the same.
- Price includes your choice of handle except for the Crystal Knobs (K150 and K155), where an upcharge applies. (Knobs and rings are not recommended for multi-point combinations.) Call RMH for pricing.
- Combinations are shown with L105 Beaver Tail Lever for illustrations purposes only. Refer to Section A for desired lever.
- Entry, Patio, and Passage functions include 8mm spindle.
- Specify metal, patina, handing, backset, door thickness, lock type, and center-to-center dimension.

	ACTIVE	DUMMY	ESCUTCHEON OPTIONS
A	 <p>E719 E719</p>		<p>A 1 3/8" x 11" Arched Escutcheon Profile Cylinder</p> <p>E719 / E719 Entry Trim* \$665.00</p> <p>E718 / E719 Patio Trim* \$612.00</p> <p>E718 / E718 Full Dummy \$453.00</p> <ul style="list-style-type: none"> • Entry Trim includes Profile cylinder and turn piece. • Patio Trim includes 1/2 Profile cylinder and turn piece. <p>Refer to spec page B40</p>
	 <p>E718 E719</p>	 <p>E718 E718</p>	
B	 <p>E718 E785</p>	 <p>E718 E718</p>	
C	 <p>E786 E787</p>	 <p>E786 E786</p>	
			<p>B 1 3/8" x 11" Arched Escutcheon American Cylinder</p> <p>E718 / E785 Patio Trim* \$532.00</p> <p>E718 / E718 Passage Trim \$487.00</p> <p>E718 / E718 Full Dummy \$453.00</p> <ul style="list-style-type: none"> • Patio Trim includes turn piece. <p>Refer to spec page B40</p>
			<p>C 1 3/8" x 11" Arched Escutcheon American Cylinder</p> <p>E786 / E787 Patio Trim* \$532.00</p> <p>E786 / E786 Passage Trim \$487.00</p> <p>E786 / E786 Full Dummy \$453.00</p> <ul style="list-style-type: none"> • Patio Trim includes turn piece. <p>Refer to spec page B40</p>
			<p>* The center to center dimension will need to be verified before set can be ordered.</p>

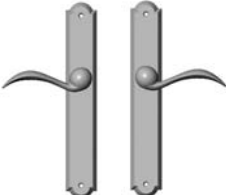

- All finishes are priced the same.
- Price includes your choice of handle except for the Crystal Knobs (K150 and K155), where an upcharge applies. (Knobs and rings are not recommended for multi-point combinations.) Call RMH for pricing.
- Combinations are shown with L105 Beaver Tail Lever for illustrations purposes only. Refer to Section A for desired lever.
- Entry, Patio, and Passage functions include 8mm spindle.
- Specify metal, patina, handing, backset, door thickness, lock type, and center-to-center dimension.

ACTIVE	DUMMY	ESCUTCHEON OPTIONS								
<p>A</p>  <p>E775 E777</p>  <p>E776 E777</p>	 <p>E776 E776</p>	<p>A 1 3/4" x 10" Arched Escutcheon (105 mm c-to-c) American Cylinder</p> <table border="0"> <tr> <td>E775 / E777 Entry Trim*</td> <td>\$594.00</td> </tr> <tr> <td>E776 / E777 Patio Trim*</td> <td>\$555.00</td> </tr> <tr> <td>E776 / E776 Passage Trim</td> <td>\$519.00</td> </tr> <tr> <td>E776 / E776 Full Dummy</td> <td>\$474.00</td> </tr> </table> <ul style="list-style-type: none"> • Entry Trim includes American cylinder and turn piece. • Patio Trim includes turn piece. <p>Refer to spec page B40</p> <p>* The center to center dimension will need to be verified before set can be ordered.</p>	E775 / E777 Entry Trim*	\$594.00	E776 / E777 Patio Trim*	\$555.00	E776 / E776 Passage Trim	\$519.00	E776 / E776 Full Dummy	\$474.00
E775 / E777 Entry Trim*	\$594.00									
E776 / E777 Patio Trim*	\$555.00									
E776 / E776 Passage Trim	\$519.00									
E776 / E776 Full Dummy	\$474.00									



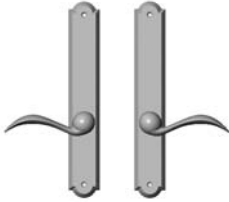

- All finishes are priced the same.
- Price includes your choice of handle except for the Crystal Knobs (K150 and K155), where an upcharge applies. (Knobs and rings are not recommended for multi-point combinations.) Call RMH for pricing.
- Combinations are shown with L105 Beaver Tail Lever for illustrations purposes only. Refer to Section A for desired lever.
- Entry, Patio, and Passage functions include 8mm spindle.
- Specify metal, patina, handing, backset, door thickness, lock type, and center-to-center dimension.

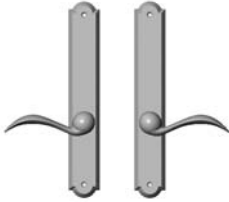
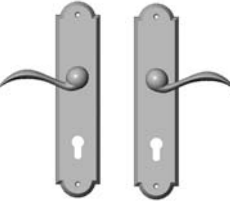
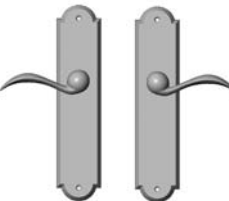
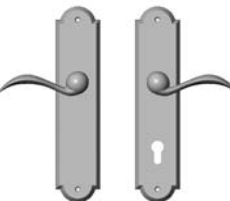
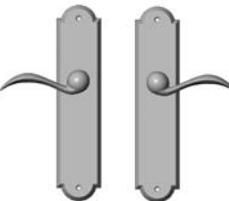
ACTIVE	DUMMY	ESCUTCHEON OPTIONS
<p>A</p>  <p>E748 E748</p>	 <p>E746 E746</p>	<p>A 1 3/4" x 11" Arched Escutcheon Profile Cylinder</p> <p>E748 / E748 Entry Trim* \$ 686.00 E746 / E748 Patio Trim*..... \$ 633.00 E746 / E746 Full Dummy \$ 474.00</p> <ul style="list-style-type: none"> • Entry Trim includes Profile cylinder and turn piece. • Patio Trim includes 1/2 Profile cylinder and turn piece. <p>Refer to spec page B41</p>
 <p>E746 E748</p>		<p>B 1 3/4" x 11" Arched Escutcheon American Cylinder</p> <p>E745 / E747 Entry Trim* \$ 594.00 E746 / E747 Patio Trim*..... \$ 555.00 E746 / E746 Passage Trim \$ 519.00 E746 / E746 Full Dummy \$ 474.00</p> <ul style="list-style-type: none"> • Entry Trim includes American cylinder and turn piece. • Patio Trim includes turn piece. <p>Refer to spec page B41</p>
<p>B</p>  <p>E745 E747</p>	 <p>E746 E746</p>	<p>* The center to center dimension will need to be verified before set can be ordered.</p>
 <p>E746 E747</p>		



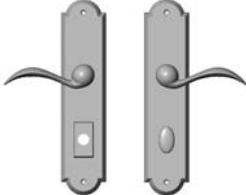

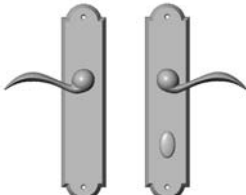
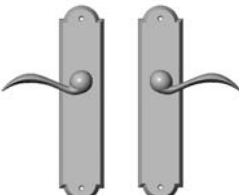
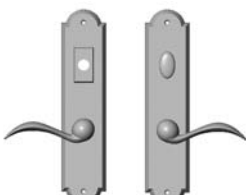

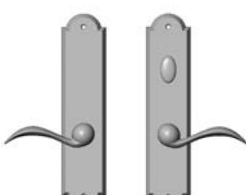
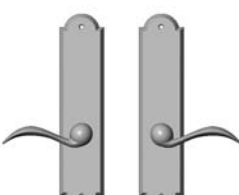
- All finishes are priced the same.
- Price includes your choice of handle except for the Crystal Knobs (K150 and K155), where an upcharge applies. (Knobs and rings are not recommended for multi-point combinations.) Call RMH for pricing.
- Combinations are shown with L105 Beaver Tail Lever for illustrations purposes only. Refer to Section A for desired lever.
- Entry, Patio, and Passage functions include 8mm spindle.
- Specify metal, patina, handing, backset, door thickness, lock type, and center-to-center dimension.

ACTIVE	DUMMY	ESCUTCHEON OPTIONS
<p>A</p>  <p>E743 E742</p>	 <p>E741 E741</p>	<p>A 1 3/4" x 11" Arched Escutcheon American Cylinder E743 / E742 Entry Trim* \$594.00 E741 / E742 Patio Trim* \$555.00 E741 / E741 Passage Trim \$519.00 E741 / E741 Full Dummy \$474.00</p> <ul style="list-style-type: none"> • Entry Trim includes American cylinder and turn piece. • Patio Trim includes turn piece. <p>Refer to spec page B41</p>
 <p>E741 E742</p>	 <p>E741 E741</p>	<p>B 2 1/2" x 11" Arched Escutcheon Profile Cylinder E754 / E754 Entry Trim* \$686.00 E751 / E754 Patio Trim* \$633.00 E751 / E751 Full Dummy \$474.00</p> <ul style="list-style-type: none"> • Entry Trim includes Profile cylinder and turn piece. • Patio Trim includes 1/2 Profile cylinder and turn piece. <p>Refer to spec page B42</p>
<p>B</p>  <p>E754 E754</p>	 <p>E751 E751</p>	<p>* The center to center dimension will need to be verified before set can be ordered.</p>
 <p>E751 E754</p>	 <p>E751 E751</p>	

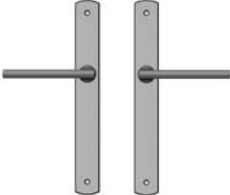
- All finishes are priced the same.
- Price includes your choice of handle except for the Crystal Knobs (K150 and K155), where an upcharge applies. (Knobs and rings are not recommended for multi-point combinations.) Call RMH for pricing.
- Combinations are shown with L105 Beaver Tail Lever for illustrations purposes only. Refer to Section A for desired lever.
- Entry, Patio, and Passage functions include 8mm spindle.
- Specify metal, patina, handing, backset, door thickness, lock type, and center-to-center dimension.

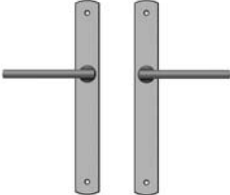
ACTIVE	DUMMY	ESCUTCHEON OPTIONS
<p>A</p>  <p>E750 E753</p>	 <p>E751 E753</p>	<p>A 2 1/2" x 11" Arched Escutcheon American Cylinder</p> <p>E750 / E753 Entry Trim* \$594.00 E751 / E753 Patio Trim*..... \$555.00 E751 / E751 Passage Trim \$519.00 E751 / E751 Full Dummy \$474.00</p> <ul style="list-style-type: none"> • Entry Trim includes American cylinder and turn piece. • Patio Trim includes turn piece. <p>Refer to spec page B42</p>
 <p>E751 E753</p>	 <p>E751 E751</p>	<p>B 2 1/2" x 11" Arched Escutcheon American Cylinder</p> <p>E757 / E756 Entry Trim* \$594.00 E755 / E756 Patio Trim*..... \$555.00 E755 / E755 Passage Trim \$519.00 E755 / E755 Full Dummy \$474.00</p> <ul style="list-style-type: none"> • Entry Trim includes American cylinder and turn piece. • Patio Trim includes turn piece. <p>Refer to spec page B42</p>
<p>B</p>  <p>E757 E756</p>	 <p>E755 E755</p>	<p>* The center to center dimension will need to be verified before set can be ordered.</p>
 <p>E755 E756</p>	 <p>E755 E755</p>	

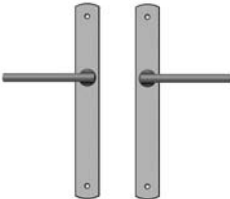

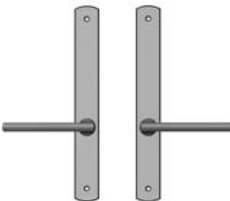
- All finishes are priced the same.
- Price includes your choice of handle except for the Crystal Knobs (K150 and K155), where an upcharge applies. (Knobs and rings are not recommended for multi-point combinations.) Call RMH for pricing.
- Combinations are shown with L135 Olympus Lever for illustrations purposes only. Refer to Section A for desired lever.
- Entry, Patio, and Passage functions include 8mm spindle.
- Specify metal, patina, handing, backset, door thickness, lock type, and center-to-center dimension.

ACTIVE	DUMMY	ESCUTCHEON OPTIONS
<p>A</p>  <p>E575 E575</p>	<p>DUMMY</p>  <p>E576 E576</p>	<p>A 1 3/8" x 11" Curved Escutcheon Profile Cylinder</p> <p>E575 / E575 Entry Trim* \$665.00 E576 / E575 Patio Trim* \$612.00 E576 / E576 Full Dummy \$453.00</p> <ul style="list-style-type: none"> • Entry Trim includes Profile cylinder and turn piece. • Patio Trim includes 1/2 Profile cylinder and turn piece. <p>Refer to spec page B51</p>
<p>B</p>  <p>E576 E575</p>	<p>DUMMY</p>  <p>E576 E576</p>	<p>B 1 3/8" x 11" Curved Escutcheon American Cylinder</p> <p>E576 / E577 Patio Trim* \$532.00 E576 / E576 Passage Trim \$487.00 E576 / E576 Full Dummy \$453.00</p> <ul style="list-style-type: none"> • Patio Trim includes turn piece. <p>Refer to spec page B51</p>
<p>B</p>  <p>E576 E577</p>	<p>DUMMY</p>  <p>E576 E576</p>	<p>C 1 3/8" x 11" Curved Escutcheon American Cylinder</p> <p>E527 / E528 Patio Trim* \$532.00 E527 / E527 Passage Trim \$487.00 E527 / E527 Full Dummy \$453.00</p> <ul style="list-style-type: none"> • Patio Trim includes turn piece. <p>Refer to spec page B51</p>
<p>C</p>  <p>E527 E528</p>	<p>DUMMY</p>  <p>E527 E527</p>	<p>* The center to center dimension will need to be verified before set can be ordered.</p>

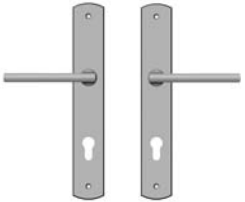
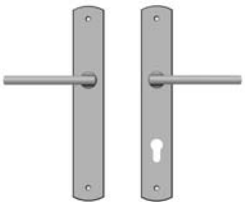
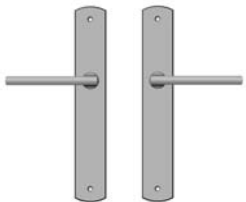
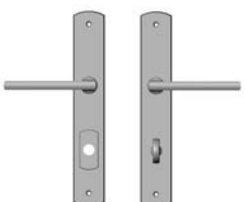
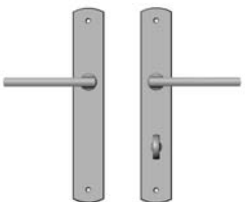
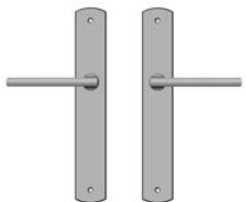
- All finishes are priced the same.
- Price includes your choice of handle except for the Crystal Knobs (K150 and K155), where an upcharge applies. (Knobs and rings are not recommended for multi-point combinations.) Call RMH for pricing.
- Combinations are shown with L135 Olympus Lever for illustrations purposes only. Refer to Section A for desired lever.
- Entry, Patio, and Passage functions include 8mm spindle.
- Specify metal, patina, handing, backset, door thickness, lock type, and center-to-center dimension.

	ACTIVE	DUMMY	ESCUTCHEON OPTIONS
A			A 1 3/4" x 11" Curved Escutcheon Profile Cylinder E532 / E532 Entry Trim* \$686.00 E530 / E532 Patio Trim*..... \$633.00 E530 / E530 Full Dummy \$474.00 • Entry Trim includes Profile cylinder and turn piece. • Patio Trim includes 1/2 Profile cylinder and turn piece. Refer to spec page B51
	E532 E532		
			
	E530 E532		
B			B 1 3/4" x 11" Curved Escutcheon American Cylinder E538 / E536 Entry Trim* \$594.00 E530 / E536 Patio Trim*..... \$555.00 E530 / E530 Passage Trim \$519.00 E530 / E530 Full Dummy \$474.00 • Entry Trim includes American cylinder and turn piece. • Patio Trim includes turn piece. Refer to spec page B51 * The center to center dimension will need to be verified before set can be ordered.
		E530 E530	
			
	E538 E536		
			
	E530 E536	E530 E530	

- All finishes are priced the same.
- Price includes your choice of handle except for the Crystal Knobs (K150 and K155), where an upcharge applies. (Knobs and rings are not recommended for multi-point combinations.) Call RMH for pricing.
- Combinations are shown with L135 Olympus Lever for illustrations purposes only. Refer to Section A for desired lever.
- Entry, Patio, and Passage functions include 8mm spindle.
- Specify metal, patina, handing, backset, door thickness, lock type, and center-to-center dimension.

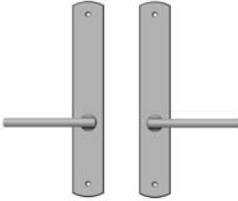
ACTIVE	DUMMY	ESCUTCHEON OPTIONS								
<p>A</p>  <p>E539 E537</p>  <p>E531 E537</p>	 <p>E531 E531</p>	<p>A 1 3/4" x 11" Curved Escutcheon American Cylinder</p> <table border="0"> <tr> <td>E539 / E537 Entry Trim*</td> <td>\$ 594.00</td> </tr> <tr> <td>E531 / E537 Patio Trim*</td> <td>\$ 555.00</td> </tr> <tr> <td>E531 / E531 Passage Trim</td> <td>\$ 519.00</td> </tr> <tr> <td>E531 / E531 Full Dummy</td> <td>\$ 474.00</td> </tr> </table> <ul style="list-style-type: none"> • Entry Trim includes American cylinder and turn piece. • Patio Trim includes turn piece. <p>Refer to spec page B51</p> <p>* The center to center dimension will need to be verified before set can be ordered.</p>	E539 / E537 Entry Trim*	\$ 594.00	E531 / E537 Patio Trim*	\$ 555.00	E531 / E531 Passage Trim	\$ 519.00	E531 / E531 Full Dummy	\$ 474.00
E539 / E537 Entry Trim*	\$ 594.00									
E531 / E537 Patio Trim*	\$ 555.00									
E531 / E531 Passage Trim	\$ 519.00									
E531 / E531 Full Dummy	\$ 474.00									

- All finishes are priced the same.
- Price includes your choice of handle except for the Crystal Knobs (K150 and K155), where an upcharge applies. (Knobs and rings are not recommended for multi-point combinations.) Call RMH for pricing.
- Combinations are shown with L105 Beaver Tail Lever for illustrations purposes only. Refer to Section A for desired lever.
- Entry, Patio, and Passage functions include 8mm spindle.
- Specify metal, patina, handing, backset, door thickness, lock type, and center-to-center dimension.

ACTIVE

DUMMY

ESCUTCHEON OPTIONS

A

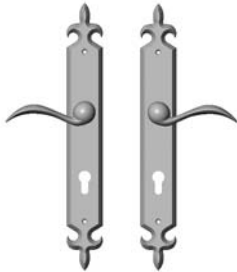

E825 E825

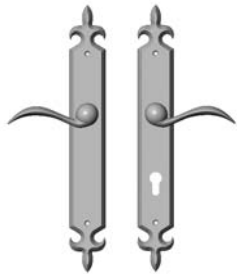

E824 E825

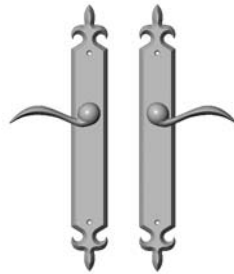

E824 E824

A 2" x 15" Fleur De Lis Escutcheon

Profile Cylinder

E825 / E825 Entry Trim* \$686.00

E824 / E825 Patio Trim* \$633.00



E824 / E824 Full Dummy \$474.00

- Entry Trim includes Profile cylinder and turn piece.
- Patio Trim includes 1/2 Profile cylinder and turn piece.

Refer to spec page B58

* The center to center dimension will need to be verified before set can be ordered.

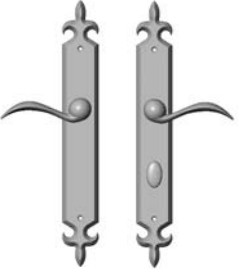
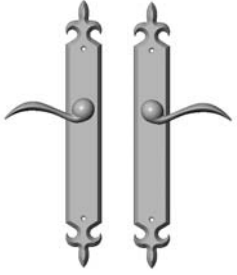
- All finishes are priced the same.
- Price includes your choice of handle except for the Crystal Knobs (K150 and K155), where an upcharge applies. (Knobs and rings are not recommended for multi-point combinations.) Call RMH for pricing.
- Combinations are shown with L105 Beaver Tail Lever for illustrations purposes only. Refer to Section A for desired lever.
- Entry, Patio, and Passage functions include 8mm spindle.
- Specify metal, patina, handing, backset, door thickness, lock type, and center-to-center dimension.

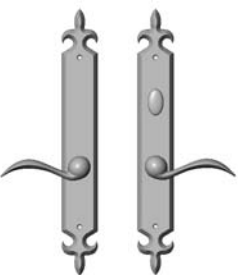
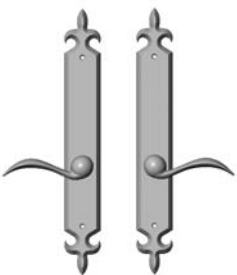
	ACTIVE	DUMMY	ESCUTCHEON OPTIONS
A			<p>A 2" x 15" Fleur De Lis Escutcheon American Cylinder</p> <p>E826 / E827 Entry Trim* \$594.00</p> <p>E824 / E827 Patio Trim*..... \$555.00</p> <p>E824 / E824 Passage Trim \$519.00</p> <p>E824 / E824 Full Dummy \$474.00</p> <ul style="list-style-type: none"> • Entry Trim includes American cylinder and turn piece. • Patio Trim includes turn piece. <p>Refer to spec page B58</p> <p>* The center to center dimension will need to be verified before set can be ordered.</p>
			
			
B			<p>B 2" x 15" Fleur De Lis Escutcheon American Cylinder</p> <p>E819 / E818 Entry Trim* \$594.00</p> <p>E817 / E818 Patio Trim*..... \$555.00</p> <p>E817 / E817 Passage Trim \$519.00</p> <p>E817 / E817 Full Dummy \$474.00</p> <ul style="list-style-type: none"> • Entry Trim includes American cylinder and turn piece. • Patio Trim includes turn piece. <p>Refer to spec page B58</p> <p>* The center to center dimension will need to be verified before set can be ordered.</p>
			
			

- All finishes are priced the same.
- Price includes your choice of handle except for the Crystal Knobs (K150 and K155), where an upcharge applies. (Knobs and rings are not recommended for multi-point combinations.) Call RMH for pricing.
- Combinations are shown with L10801 Briggs Lever for illustrations purposes only. Refer to Section A for desired lever.
- Entry, Patio, and Passage functions include 8mm spindle.
- Specify metal, patina, handing, backset, door thickness, lock type, and center-to-center dimension.

	ACTIVE	DUMMY	ESCUTCHEON OPTIONS
A			A 2" x 15" Briggs Escutcheon Profile Cylinder E10873 / E10873 Entry Trim* \$ 686.00 E10871 / E10873 Patio Trim* \$ 633.00 E10871 / E10871 Full Dummy..... \$ 474.00 • Entry Trim includes Profile cylinder and turn piece. • Patio Trim includes 1/2 Profile cylinder turn piece. Refer to spec page B63
	E10873 E10873		
	E10871 E10873		
		E10871 E10871	
B			B 2" x 15" Briggs Escutcheon American Cylinder E10870 / E10872 Entry Trim* \$ 610.00 E10871 / E10872 Patio Trim* \$ 571.00 E10871 / E10871 Passage Trim \$ 519.00 E10871 / E10871 Full Dummy..... \$ 474.00 • Entry Trim includes American cylinder and turn piece. • Patio Trim includes turn piece. Refer to spec page B63 * The center to center dimension will need to be verified before set can be ordered.
	E10870 E10872		
	E10871 E10872		
		E10871 E10871	

- All finishes are priced the same.
- Price includes your choice of handle except for the Crystal Knobs (K150 and K155), where an upcharge applies. (Knobs and rings are not recommended for multi-point combinations.) Call RMH for pricing.
- Combinations are shown with L10801 Briggs Lever for illustrations purposes only. Refer to Section A for desired lever.
- Entry, Patio, and Passage functions include 8mm spindle.
- Specify metal, patina, handing, backset, door thickness, lock type, and center-to-center dimension.

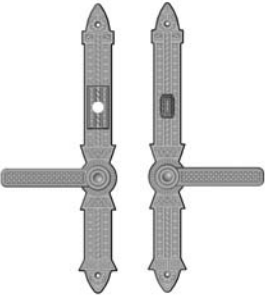
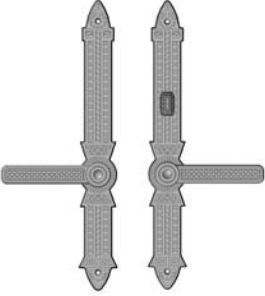
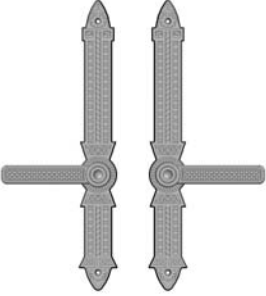
	ACTIVE	DUMMY	ESCUTCHEON OPTIONS
A	 <p>E10875 E10876</p>  <p>E10874 E10876</p>	 <p>E10874 E10874</p>	<p>A 2" x 15" Briggs Escutcheon</p> <p>American Cylinder</p> <p>E10875 / E10876 Entry Trim* \$ 610.00</p> <p>E10874 / E10876 Patio Trim* \$ 571.00</p> <p>E10874 / E10874 Passage Trim \$ 519.00</p> <p>E10874 / E10874 Full Dummy. \$ 474.00</p> <ul style="list-style-type: none"> • Entry Trim includes American cylinder and turn piece. • Patio Trim includes turn piece. <p>Refer to spec page B63</p> <p>* The center to center dimension will need to be verified before set can be ordered.</p>



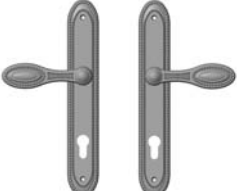
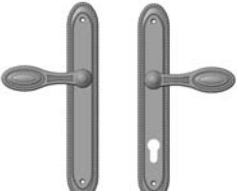
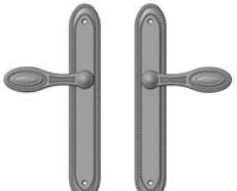
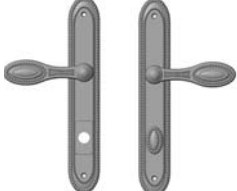
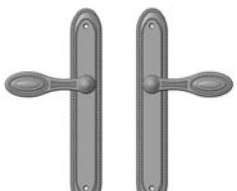

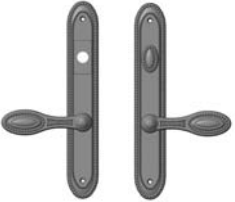
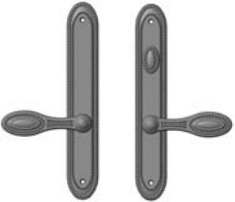
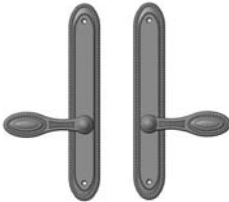

- All finishes are priced the same.
- Price includes your choice of handle except for the Crystal Knobs (K150 and K155), where an upcharge applies. (Knobs and rings are not recommended for multi-point combinations.) Call RMH for pricing.
- Combinations are shown with L580 Maddox Lever for illustrations purposes only. Refer to Section A for desired lever.
- Entry, Patio, and Passage functions include 8mm spindle.
- Specify metal, patina, handing, backset, door thickness, lock type, and center-to-center dimension.

	ACTIVE	DUMMY	ESCUTCHEON OPTIONS
A			A 1 3/4" x 11" Maddox Escutcheon Profile Cylinder E592 / E592 Entry Trim* \$ 924.00 E591 / E592 Patio Trim*..... \$ 856.00 E591 / E591 Full Dummy \$ 678.00 • Entry Trim includes Profile cylinder and turn piece. • Patio Trim includes 1/2 Profile cylinder and turn piece. Refer to spec page B67
	E592 E592		
			
	E591 E592		
			B 1 3/4" x 11" Maddox Escutcheon American Cylinder E595 / E597 Entry Trim* \$ 824.00 E591 / E597 Patio Trim*..... \$ 768.00 E591 / E591 Passage Trim \$ 723.00 E591 / E591 Full Dummy \$ 678.00 • Entry Trim includes American cylinder and turn piece. • Patio Trim includes turn piece. Refer to spec page B67 * The center to center dimension will need to be verified before set can be ordered.
		E591 E591	
B			
	E595 E597		
			
		E591 E591	

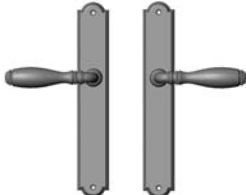

- All finishes are priced the same.
- Price includes your choice of handle except for the Crystal Knobs (K150 and K155), where an upcharge applies. (Knobs and rings are not recommended for multi-point combinations.) Call RMH for pricing.
- Combinations are shown with L580 Maddox Lever for illustrations purposes only. Refer to Section A for desired lever.
- Entry, Patio, and Passage functions include 8mm spindle.
- Specify metal, patina, handing, backset, door thickness, lock type, and center-to-center dimension.

ACTIVE	DUMMY	ESCUTCHEON OPTIONS
<p>A</p>  <p>E594 E596</p>  <p>E590 E596</p>	 <p>E590 E590</p>	<p>A 1 3/4" x 11" Maddox Escutcheon</p> <p>American Cylinder</p> <p>E594 / E596 Entry Trim* \$824.00</p> <p>E590 / E596 Patio Trim* \$768.00</p> <p>E590 / E590 Passage Trim \$723.00</p> <p>E590 / E590 Full Dummy \$678.00</p> <ul style="list-style-type: none"> • Entry Trim includes American cylinder and turn piece. • Patio Trim includes turn piece. <p>Refer to spec page B67</p> <p>* The center to center dimension will need to be verified before set can be ordered.</p>

- All finishes are priced the same.
- Price includes your choice of handle except for the Crystal Knobs (K150 and K155), where an upcharge applies. (Knobs and rings are not recommended for multi-point combinations.) Call RMH for pricing.
- Combinations are shown with L075 Ellis Lever for illustrations purposes only. Refer to Section A for desired lever.
- Entry, Patio, and Passage functions include 8mm spindle.
- Specify metal, patina, handing, backset, door thickness, lock type, and center-to-center dimension.

ACTIVE	DUMMY	ESCUTCHEON OPTIONS
<p>A</p>  <p>E046 E046</p>	 <p>E041 E041</p>	<p>A 1 3/4" x 11" Ellis Escutcheon Profile Cylinder</p> <p>E046 / E046 Entry Trim* \$924.00 E041 / E046 Patio Trim*..... \$856.00 E041 / E041 Full Dummy \$678.00</p> <ul style="list-style-type: none"> • Entry Trim includes Profile cylinder and turn piece. • Patio Trim includes 1/2 Profile cylinder and turn piece. <p>Refer to spec page B74</p>
 <p>E041 E046</p>	 <p>E041 E041</p>	<p>B 1 3/4" x 11" Ellis Escutcheon American Cylinder</p> <p>E045 / E043 Entry Trim* \$824.00 E041 / E043 Patio Trim*..... \$768.00 E041 / E041 Passage Trim \$723.00 E041 / E041 Full Dummy \$678.00</p> <ul style="list-style-type: none"> • Entry Trim includes American cylinder and turn piece. • Patio Trim includes turn piece. <p>Refer to spec page B74</p>
<p>B</p>  <p>E045 E043</p>	 <p>E041 E041</p>	<p>* The center to center dimension will need to be verified before set can be ordered.</p>
 <p>E041 E043</p>	 <p>E041 E041</p>	

- All finishes are priced the same.
- Price includes your choice of handle except for the Crystal Knobs (K150 and K155), where an upcharge applies. (Knobs and rings are not recommended for multi-point combinations.) Call RMH for pricing.
- Combinations are shown with L075 Ellis Lever for illustrations purposes only. Refer to Section A for desired lever.
- Entry, Patio, and Passage functions include 8mm spindle.
- Specify metal, patina, handing, backset, door thickness, lock type, and center-to-center dimension.

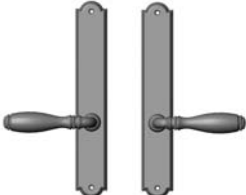
ACTIVE	DUMMY	ESCUTCHEON OPTIONS
<p>A</p>  <p>E044 E042</p>  <p>E040 E042</p>	 <p>E040 E040</p>	<p>A 1 3/4" x 11" Ellis Escutcheon American Cylinder E044 / E042 Entry Trim* \$ 824.00 E040 / E042 Patio Trim*..... \$ 768.00 E040 / E040 Passage Trim \$ 723.00 E040 / E040 Full Dummy \$ 678.00</p> <ul style="list-style-type: none"> • Entry Trim includes American cylinder and turn piece. • Patio Trim includes turn piece. <p>Refer to spec page B74</p> <p>* The center to center dimension will need to be verified before set can be ordered.</p>

- All finishes are priced the same.
- Price includes your choice of handle except for the Crystal Knobs (K150 and K155), where an upcharge applies. (Knobs and rings are not recommended for multi-point combinations.) Call RMH for pricing.
- Combinations are shown with L21005 Emile Lever for illustrations purposes only. Refer to Section A for desired lever.
- Entry, Patio, and Passage functions include 8mm spindle.
- Specify metal, patina, handing, backset, door thickness, lock type, and center-to-center dimension.

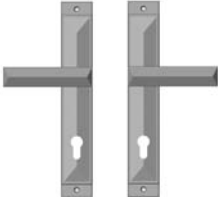
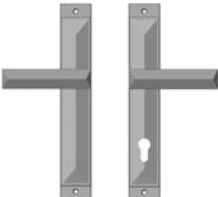
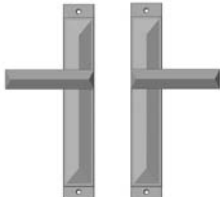
ACTIVE	DUMMY	ESCUTCHEON OPTIONS
<p>A</p>  <p>E21046 E21046</p>  <p>E21041 E21046</p>	 <p>E21041 E21041</p>	<p>A 1 3/4" x 11" Mack Escutcheon Profile Cylinder E21046 / E21046 Entry Trim* \$ 686.00 E21041 / E21046 Patio Trim* \$ 633.00 E21041 / E21041 Full Dummy \$ 474.00</p> <ul style="list-style-type: none"> • Entry Trim includes Profile cylinder and turn piece. • Patio Trim includes 1/2 Profile cylinder and turn piece. <p>Refer to spec page B81</p> <p>* The center to center dimension will need to be verified before set can be ordered.</p>

- All finishes are priced the same.
- Price includes your choice of handle except for the Crystal Knobs (K150 and K155), where an upcharge applies. (Knobs and rings are not recommended for multi-point combinations.) Call RMH for pricing.
- Combinations are shown with L21005 Emile Lever for illustrations purposes only. Refer to Section A for desired lever.
- Entry, Patio, and Passage functions include 8mm spindle.
- Specify metal, patina, handing, backset, door thickness, lock type, and center-to-center dimension.

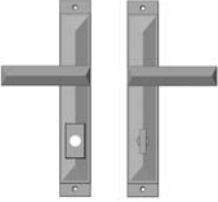
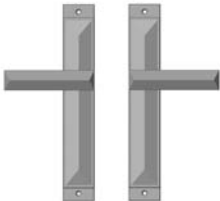
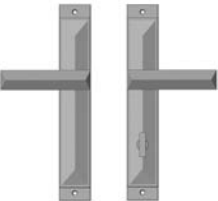
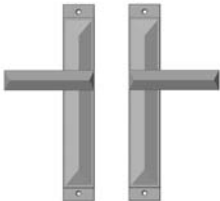
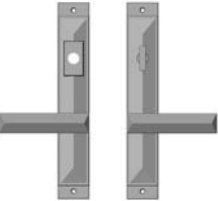
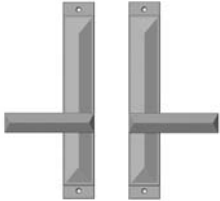
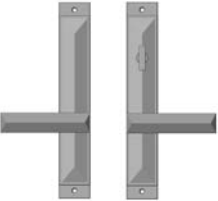
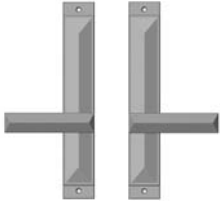
ACTIVE	DUMMY	ESCUTCHEON OPTIONS
<p>A</p>  <p>E21045 E21043</p>	 <p>E21041 E21041</p>	<p>A 1 3/4" x 11" Mack Escutcheon American Cylinder E21045 / E21043 Entry Trim* \$594.00 E21041 / E21043 Patio Trim* \$555.00 E21041 / E21041 Passage Trim \$519.00 E21041 / E21041 Full Dummy \$474.00</p> <ul style="list-style-type: none"> • Entry Trim includes American cylinder and turn piece. • Patio Trim includes turn piece. Refer to spec page B81
 <p>E21041 E21043</p>	 <p>E21041 E21041</p>	<p>B 1 3/4" x 11" Mack Escutcheon American Cylinder E21044 / E21042 Entry Trim* \$594.00 E21040 / E21042 Patio Trim* \$555.00 E21040 / E21040 Passage Trim \$519.00 E21040 / E21040 Full Dummy \$474.00</p> <ul style="list-style-type: none"> • Entry Trim includes American cylinder and turn piece. • Patio Trim includes turn piece. • Entry, Patio, and Passage trim includes an 8mm spindle. Refer to spec page B81 <p>* The center to center dimension will need to be verified before set can be ordered.</p>
<p>B</p>  <p>E21044 E21042</p>	 <p>E21040 E21040</p>	
 <p>E21040 E21042</p>	 <p>E21040 E21040</p>	